

GÜÇLÜ BİR GELECEK İÇİN STRONGER FOR THE FUTURE



www.activent.com.tr



ACTIVENT®

ÜRÜN KATALOĞU
PRODUCT CATALOGUE



RADYAL FANLAR
RADIAL FANS



RSVR

ÖNE EĞİMLİ VE SEYREK KANATLI
TEK EMİŞLİ GALVANİZ RADYAL FANLAR

INDUSTRIAL GALVANİZE RADIAL FANS
(FORWARD CURVED) LOW PRESSURE

RSVR Alçak basınç sistemleri için tasarlanmış bu fanlar her türlü tesis havalandırmasında kullanılabilirler. Vidalı kasa sistemi sayesinde kasa istenen atış pozisyonuna rahatlıkla çevrilebilir. En ekonomik havalandırma çözümlerinden biridir. Kanat yapısı seyrek oluşu sayesinde pervane temizliği kolaydır. Komple galvaniz sacdan üretilmektedir.

MALZEME

Komple galvaniz sacdan üretilmiştir. Pervane yapısı geriye eğimli ve seyrek kanatlıdır.

HIZ KONTROLÜ

Opsiyonel olarak frekans inverterleri ile sağlanabilirler.

KULLANIM ALANLARI

İş yerleri, ofisler, fabrikalar, hastaneler, restoranlar, toplantı salonları, süpermarketler, alışveriş merkezleri vb.

For low pressure systems These fans designed for all kinds of facilities. They can be used in ventilation. Thanks to the screw case system, the case comfortably to the desired shooting position translatable. The most economical ventilation It is one of the solutions. Wing structure propeller cleaning due to its sparseness is easy. Completely made of galvanized sheet are produced.

MATERIAL

It is completely made of galvanized sheet. Propeller structure is sloping forward and It has few wings.

SPEED CONTROL

Optionally with frequency inverters they can provide.

USAGE AREAS

Workplaces, offices, factories, hospitals, restaurants, meeting halls, supermarkets, shopping centers etc.

Tip/Kod Type/Code	Elektrik Motoru / Electrical Motor				Max. Debi Air Flow m ³ / h	Max. Basınç Kaybı Pressure Pa
	Voltaj Voltage	Güç Power		Devir Speed		
	(V)	(HP)	(kW)	(d/d)		
RSVR-0,50-T-4K	380	0,50	0,37	1.380	2.500	250
RSVR-1,00-T-4K	380	1,00	0,75	1.410	5.000	300
RSVR-1,50-T-4K	380	1,50	1,10	1.430	6.000	300
RSVR-2,00-T-4K	380	2,00	1,50	1.430	8.000	300
RSVR-3,00-T-4K	380	3,00	2,20	1.435	10.000	300
RSVR-4,00-T-4K	380	4,00	3,00	1.435	11.000	350
RSVR-5,50-T-4K	380	5,50	4,00	1.455	13.000	350
RSVR-7,50-T-4K	380	7,50	5,50	1.465	16.000	350

TEKNİK ÖLÇÜLER / TECHNICAL DIMENSION

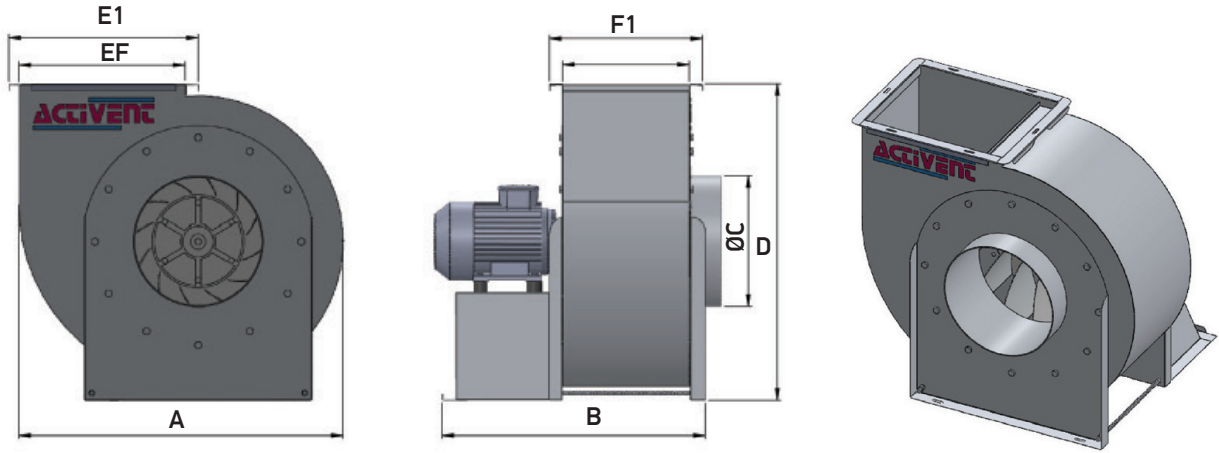

Tip/Kod Type/Code	Ölçüler / Sizes (mm)							
	A	B	ØC	D	E	E1	F	F1
RSVR-0,50-T-4K	520	420	195	510	240	295	200	255
RSVR-1,00-T-4K	610	480	245	600	330	390	210	265
RSVR-1,50-T-4K	740	590	295	720	370	430	285	350
RSVR-2,00-T-4K	740	590	295	720	370	430	285	350
RSVR-3,00-T-4K	780	695	345	760	435	490	330	395
RSVR-4,00-T-4K	780	695	345	760	435	490	330	395
RSVR-5,50-T-4K	790	705	395	780	495	560	340	410
RSVR-7,50-T-4K	950	890	445	920	465	610	435	510

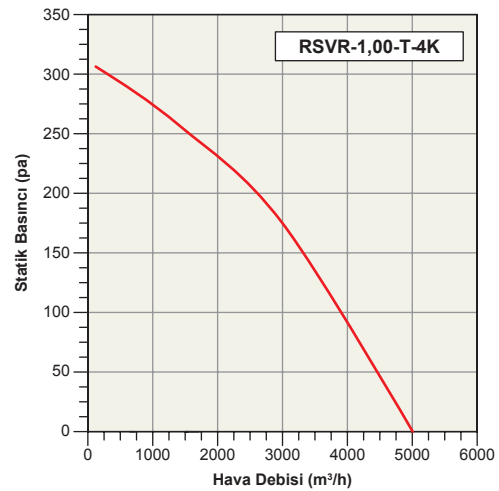
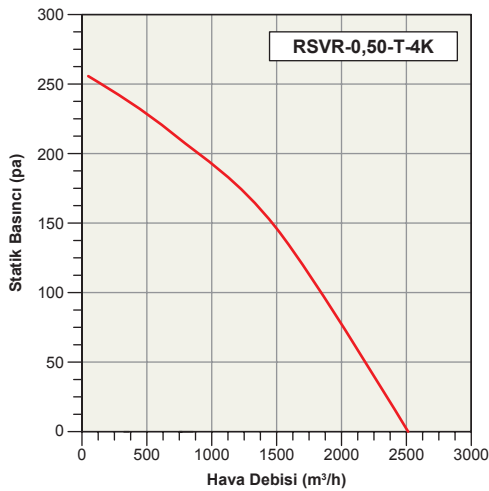

3 RADYAL FANLAR RADIAL FANS

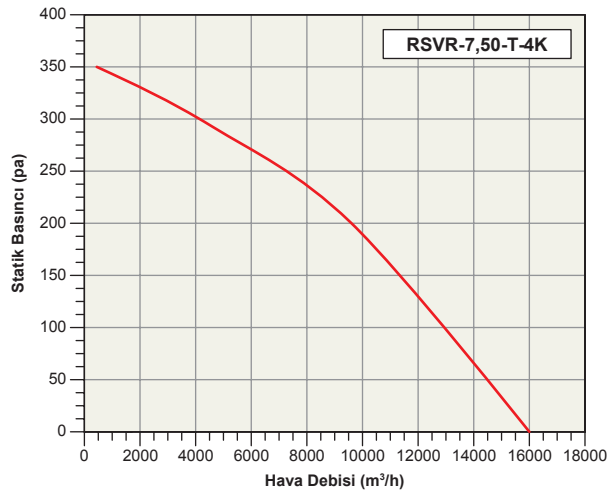
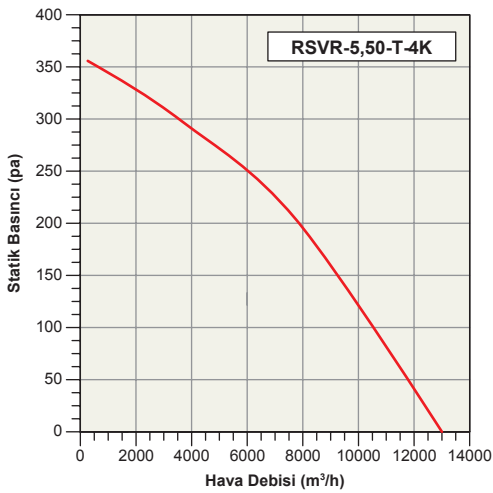
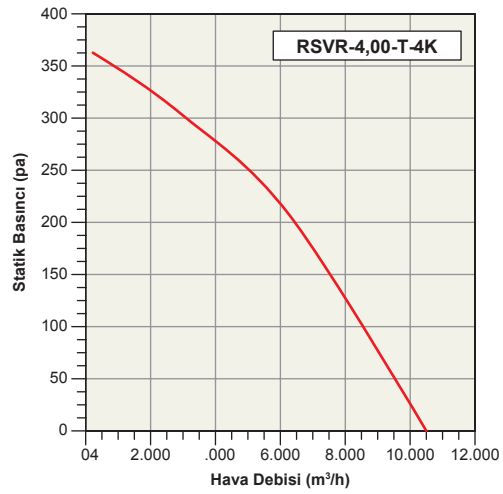
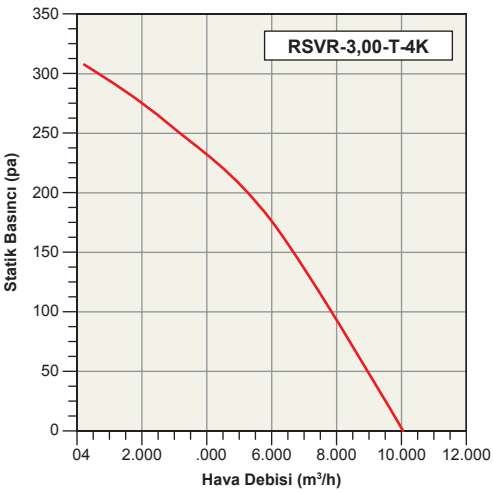
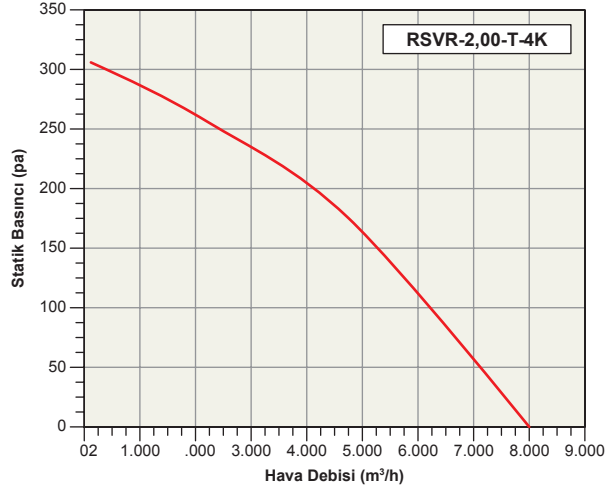
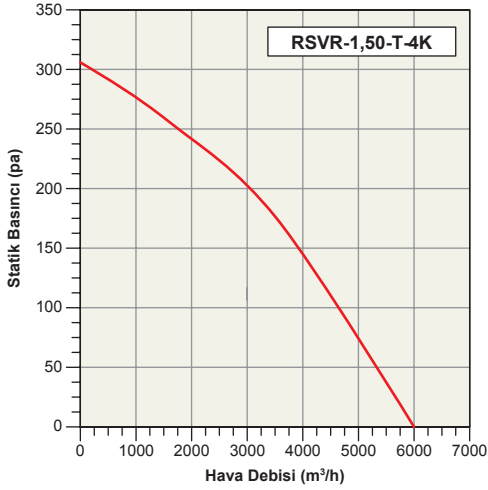

Discover the potential



NOT

Lined writing area consisting of 20 horizontal lines.

ACTIVENT®

Halkalı Merkez Mahallesi
Şehit Yılmaz Özdemir Caddesi
Sanayi Sokak No: 4
Küçükçekmece, İstanbul, Türkiye

P: +90.212 698 02 25

P: +90.212 698 02 26

P: +90.212 565 73 03

info@activent.com.tr

www.activent.com.tr

