

# GÜÇLÜ BİR GELECEK İÇİN STRONGER FOR THE FUTURE



[www.activent.com.tr](http://www.activent.com.tr)



## ACTIVENT®

ÜRÜN KATALOĞU  
PRODUCT CATALOGUE

# 4 KANAL TİPİ FANLAR DUCT TYPE FANS



## KAKF

MIXED FLOW  
DUCT TYPE

These fans, which work with high efficiency and low noise level, are extremely practical with their strong air flow and easy installation. Both mouths are suitable for the channel diameter. They have the ability to work in any mounting position.

Type/Code	Volt/Freq	LOW				HI				Unit Price
		Input Power	Air Vol	Pressure	Noise dB	Input Power	Air Vol	Pressure	Noise dB	
	(V~/Hz)	(W)	(m <sup>3</sup> /h)	(Pa)	(A)	(W)	(m <sup>3</sup> /h)	(Pa)	(A)	(USD / QTY)
KAKF-100-M-2K	220/50	24	138	100	46	33	198	140	56	90 \$
KAKF-125-M-2K	220/50	26	200	100	46	36	280	140	56	92 \$
KAKF-150-M-2K	220/50	45	330	150	56	55	432	220	63	135 \$
KAKF-200-M-2K	220/50	115	750	280	63	135	990	290	68	165 \$
KAKF-250-M-2K	220/50	134	1200	165	63	200	1750	330	70	285 \$
KAKF-315-M-2K	220/50	200	1680	180	63	290	2500	360	70	360 \$

### TECHNICAL DIMENSION

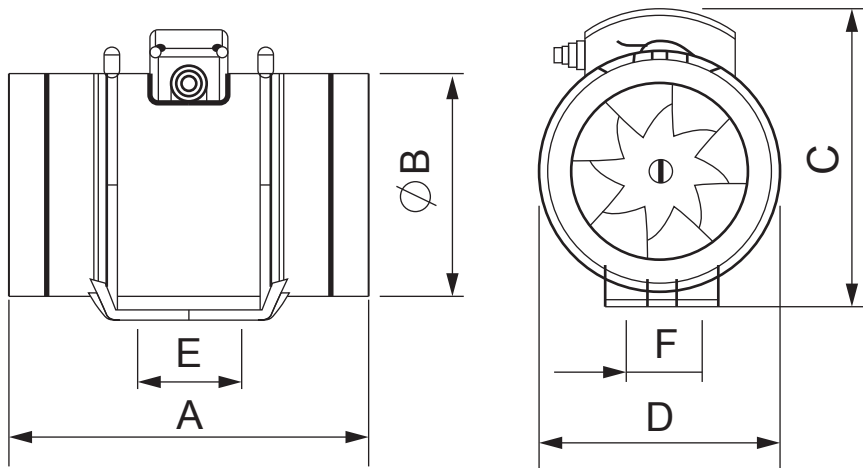

LOW

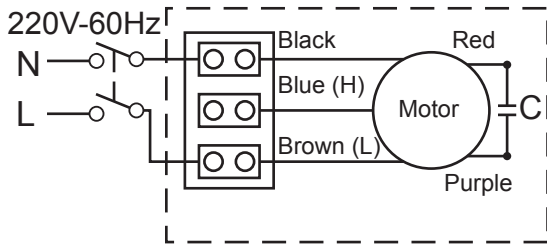

HI

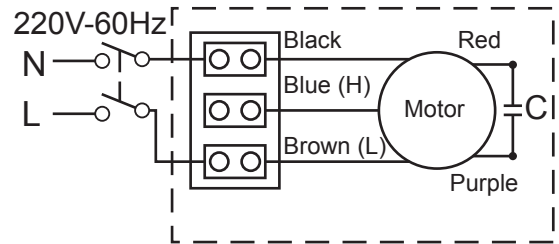

KAKF-100-M-2K / KAKF-120-M-2K / KAKF-150-M-2K / KAKF-200-M-2K

LOW

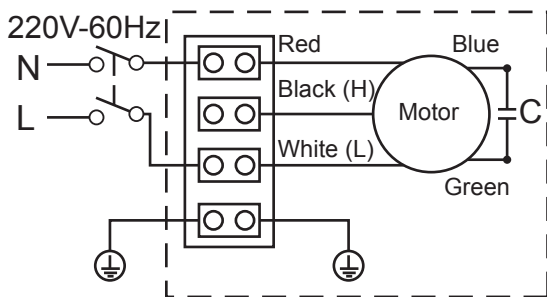

HI

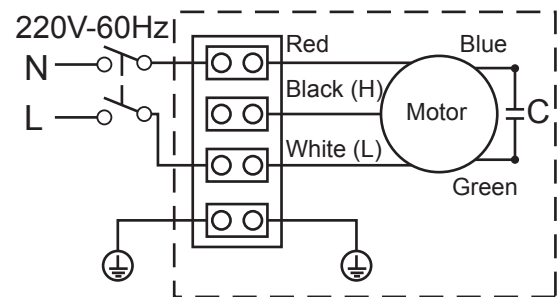

KAKF-250-M-2K / KAKF-315-M-2K

Type/Code	Dimensions mm				Installation mm	
	A	B	C	D	E	F
KAKF-100-M-2K	258	ø99	216	178	80	60
KAKF-125-M-2K	258	ø123	216	178	80	60
KAKF-150-M-2K	304	ø148	248	204	93	60
KAKF-200-M-2K	300	ø196	275	210	114	85
KAKF-250-M-2K	380	ø250	345	290	108	230
KAKF-315-M-2K	446	ø315	388	346	150	270

# 4 KANAL TİPİ FANLAR DUCT TYPE FANS

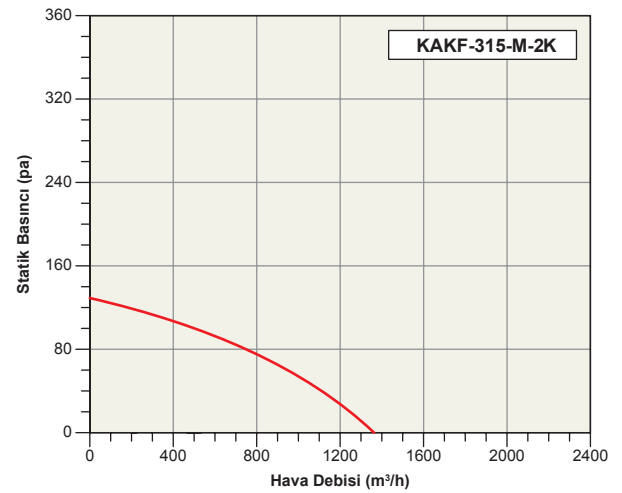
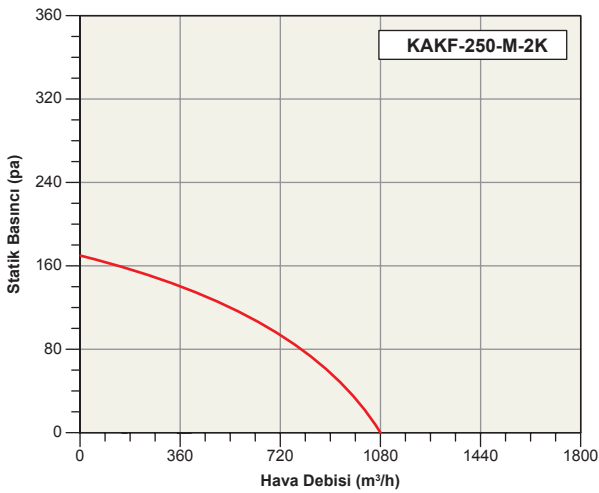
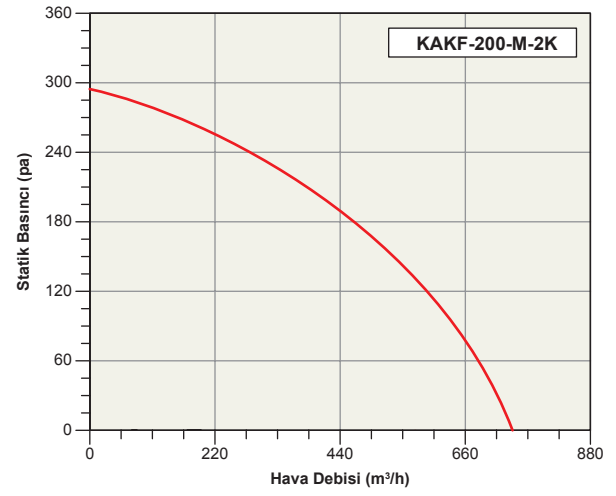
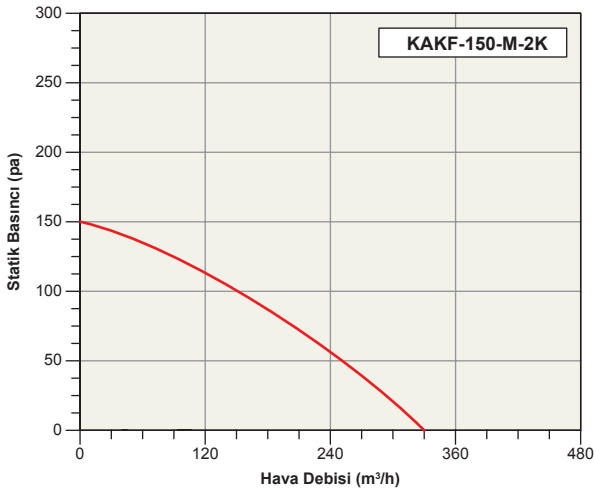
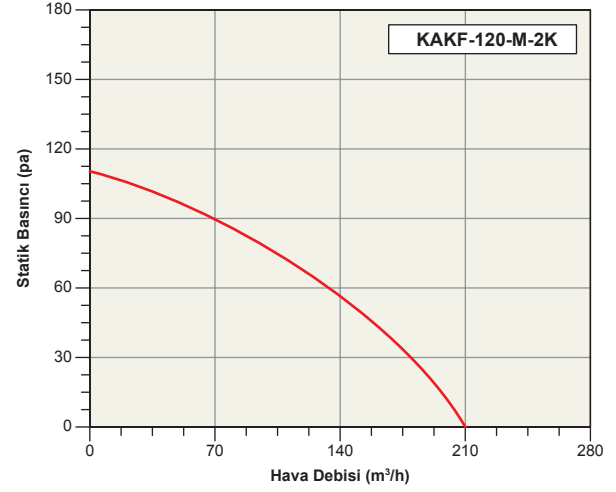
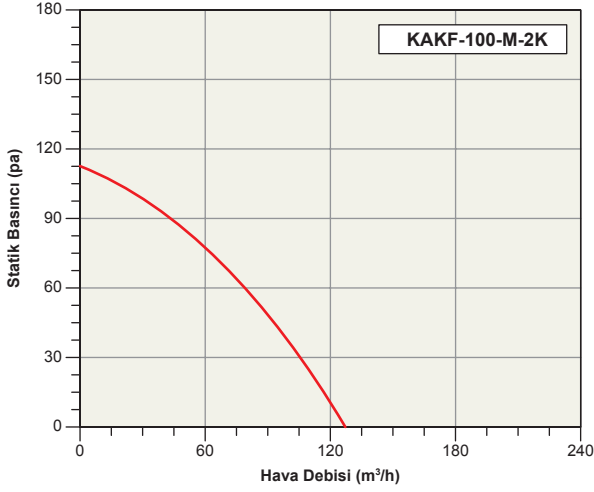

NOT



**ACTIVENT®**

Halkalı Merkez Mahallesi  
Şehit Yılmaz Özdemir Caddesi  
Sanayi Sokak No: 4  
Küçükçekmece, İstanbul, Türkiye

**P:** +90.212 698 02 25

**P:** +90.212 698 02 26

**P:** +90.212 565 73 03

[info@activent.com.tr](mailto:info@activent.com.tr)

[www.activent.com.tr](http://www.activent.com.tr)

