

GÜÇLÜ BİR GELECEK İÇİN STRONGER FOR THE FUTURE



www.activent.com.tr



ACTIVENT®

ÜRÜN KATALOĞU
PRODUCT CATALOGUE

1 HÜCRELİ ASPİRATÖRLER CABINET FAN

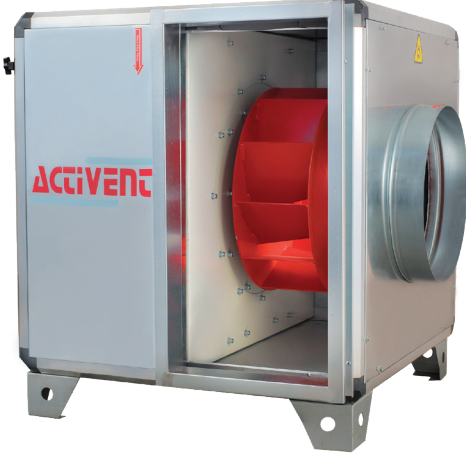

HTRA

DİREKT AKUPLE MOTORLU, TEK EMİŞLİ
RADYAL FANLI SEYREK KANATLI,
HÜCRELİ ASPİRATÖR

SINGLE SUCTION CABINET FANS
(PLUG FAN)

HTRA tek emişli santrifüj hücreli fanlar 2.500 m³/h ile 20.000 m³/h debileri arasında değişik boyutlarda üretilmektedir. Hücre panelleri 20 mm kalınlıkta ve 70 kg/m³ yoğunlukta kaya yünü izolelidir. Mutfak, davlumbaz vb. yağlı hava içerebilecek mahallerin havalandırılması için uygun çözümdür.

MALZEME

Gövdesi; Galvaniz sacdan üretilmiştir. 20 mm kalınlığında kaya yünü izolelidir. Alüminyum kafes yapısında imal edilirler. Radyal pervane, geriye eğimli kanat yapısında siyah sacdan imal edilmiştir.

HIZ KONTROLÜ

Frekans invertörü ile sağlanabilirler.

KULLANIM ALANLARI

Mutfaklar, yemekhaneler, fabrikalar, hastahaneler, restoranlar, kafeteryalar vb.

HTRA single suction centrifugal cabinet fan 2. between 500 m³/h and 20,000 m³ / h flow rates it is produced in different sizes. Cell panels 20 mm thick and 70 kg / m³ rock wool is insulated in density. Kitchen, Hood etc. may contain oily air suitable for ventilation of neighborhoods solution.

MATERIAL

Body; made of Galvanized Sheet. 20 mm thick rock wool is insulated. They are manufactured in aluminum cage structure. Radial propeller, backward inclined wing it is made of black sheet in its structure.

SPEED CONTROL

Frequency inverter can be used.

USAGE AREAS

Kitchens, dining halls, factories, hospitals, restaurants, cafeterias etc.

Tip/Kod Type/Code	Elektrik Motoru / Electrical Motor				Max. Debi Air Flow m ³ / h	Max. Basınc Kaybı Pressure Pa
	Voltaj Voltage	Güç Power		Devir Speed		
	(V)	(HP)	(kW)	(d/d) (rpm)		
HTRA-1,00-T-4K	380	1,00	0,75	1.410	2.500	400
HTRA-1,50-T-4K	380	1,50	1,10	1.430	4.000	450
HTRA-2,00-T-4K	380	2,00	1,50	1.430	6.000	500
HTRA-3,00-T-4K	380	3,00	2,20	1.435	8.000	550
HTRA-4,00-T-4K	380	4,00	3,00	1.435	10.000	600
HTRA-5,50-T-4K	380	5,50	4,00	1.455	12.000	650
HTRA-7,50-T-4K	380	7,50	5,50	1.465	16.000	700
HTRA-10,0-T-4K	380	10,0	7,50	1.465	20.000	750

TEKNİK ÖLÇÜLER / TECHNICAL DIMENSION

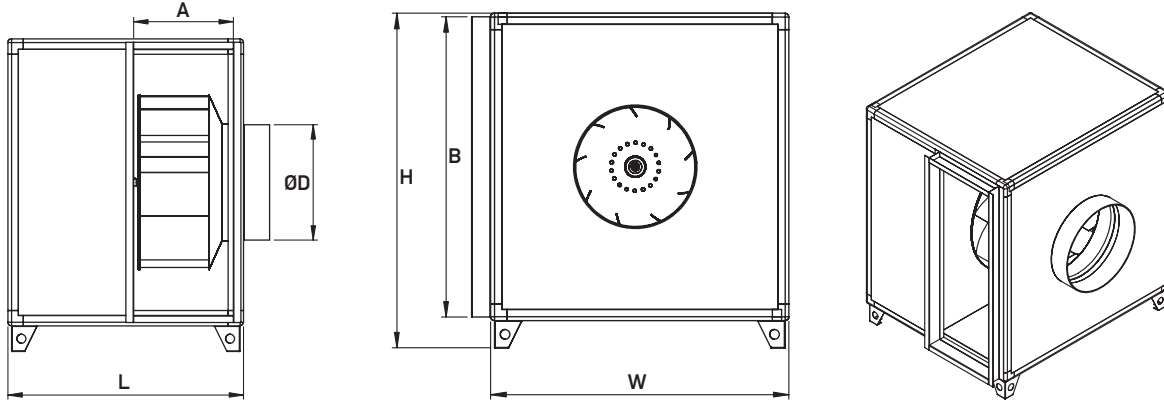

Tip/Kod Type/Code	Ölçüler / Sizes (mm)					
	L	W	H	A	B	D
HTRA-1,00-T-4K	670	670	670	150	570	300
HTRA-1,50-T-4K	720	720	720	200	620	325
HTRA-2,00-T-4K	770	770	770	200	670	350
HTRA-3,00-T-4K	820	820	820	250	720	400
HTRA-4,00-T-4K	870	870	870	250	770	450
HTRA-5,50-T-4K	920	920	920	280	820	500
HTRA-7,50-T-4K	970	970	970	300	870	560
HTRA-10,0-T-4K	970	970	970	350	870	630

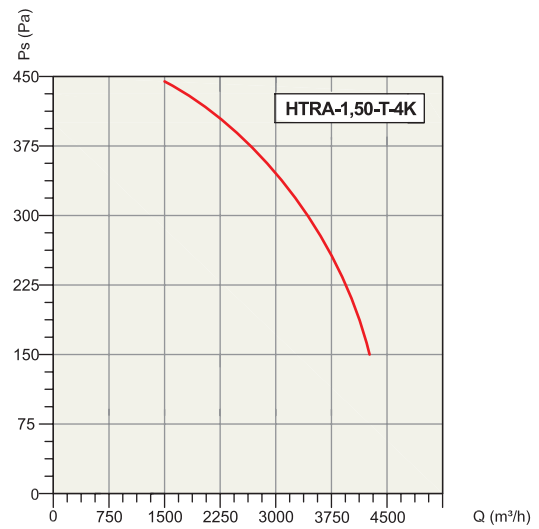
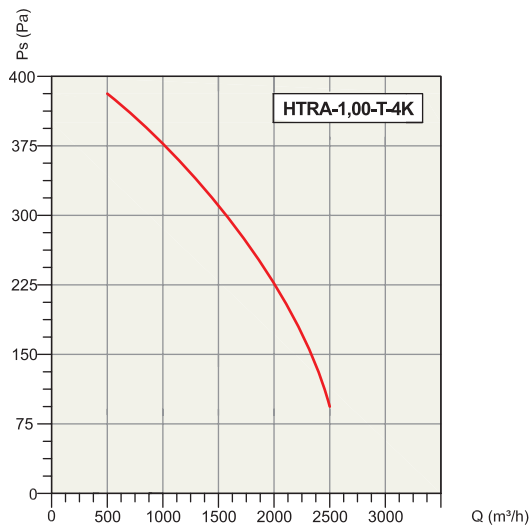

1 HÜCRELİ ASPİRATÖRLER CABINET FAN



TEKNİK ÖLÇÜLER / TECHNICAL DIMENSION

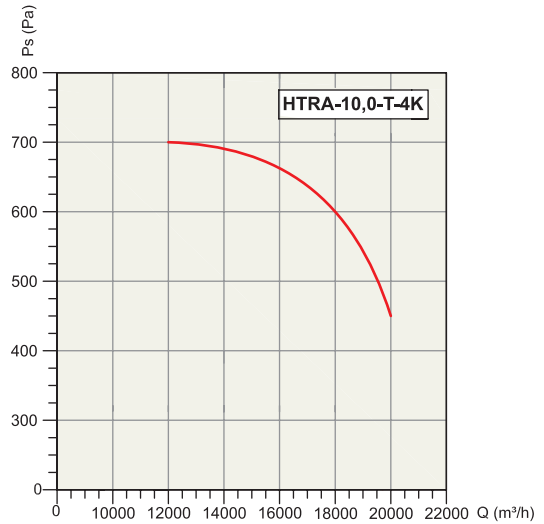
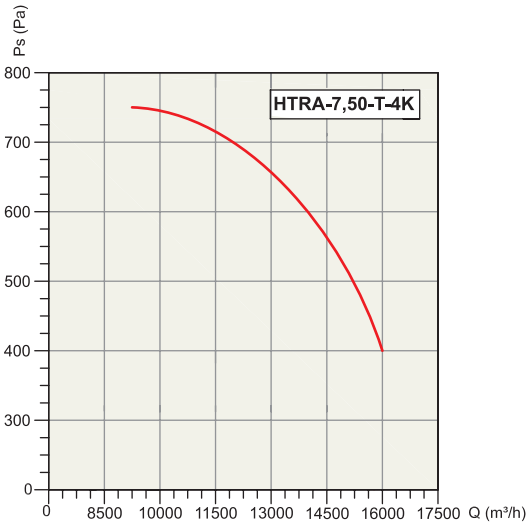
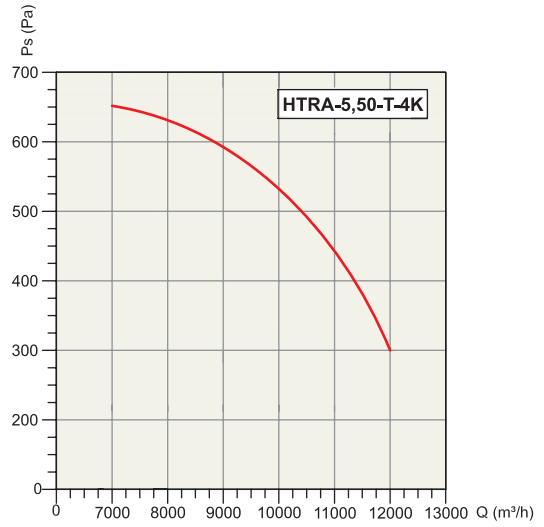
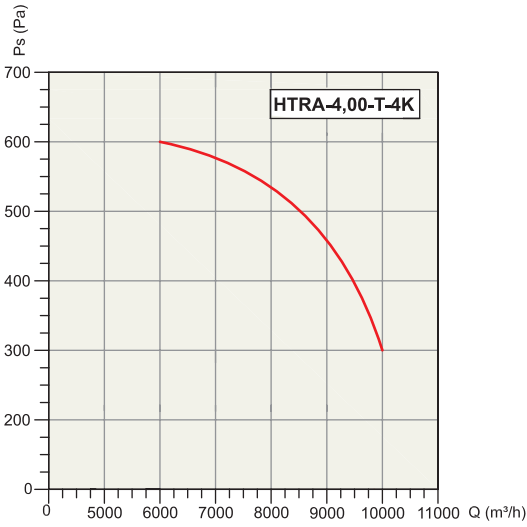
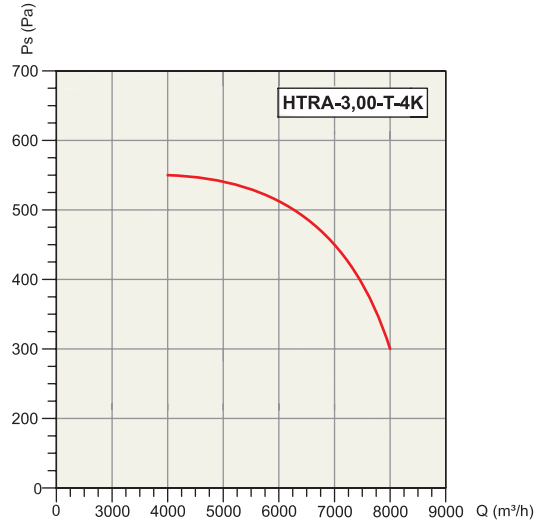
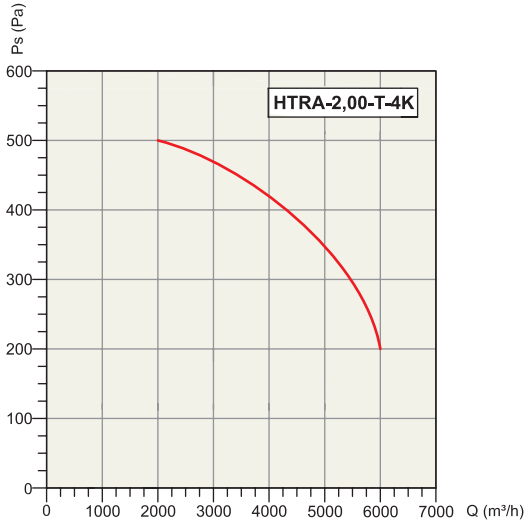

ACTIVENT®

Halkalı Merkez Mahallesi
Şehit Yılmaz Özdemir Caddesi
Sanayi Sokak No: 4
Küçükçekmece, İstanbul, Türkiye

P: +90.212 698 02 25

P: +90.212 698 02 26

P: +90.212 565 73 03

info@activent.com.tr

www.activent.com.tr

