

GÜÇLÜ BİR GELECEK İÇİN STRONGER FOR THE FUTURE



www.activent.com.tr



ACTIVENT®

ÜRÜN KATALOĞU
PRODUCT CATALOGUE

5 ÇATI TİPİ FANLAR ROOF TYPE FANS

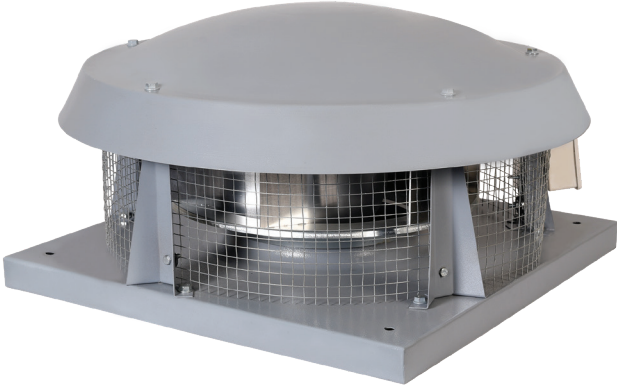

CRDR

RADYAL PERVANELİ, YATAY AKIŞLI,
KUBBE ŞAPKALI, DIŞTAN ROTORLU,
DİREKT AKUPLE MOTORLU

HORIZONTAL OUTLET ROOF FANS /
BACKWARD CURVED

CRDR kapalı ortamların havalandırmasında kullanılan bu fanlar yüksek performansları ile sorunsuz çalışabilmektedirler. Dıştan rotorlu motorları ile son derece sessiz bir çalışma yapısına sahiptirler.

MALZEME

Gövdesi; Elektrositatik toz boyalı sac Radyal fan; geriye eğimli kanat yapısı ile galvanize sacdan üretilmiştir.

HIZ KONTROLÜ

Opsiyonel kontrol cihazıyla sağlanabilir.

KULLANIM ALANLARI

Endüstriyel ve inşaa amaçlı uygulamalarda, fabrikalarda, mutfaklarda, laboratuvarlarda, davlumbazlarda, ofislerde, hastanelerde, alışveriş merkezlerinde, restoranlarda, tiyatrolarda, dairelerde, gece kulüplerinde, tavuk çiftliklerinde vd. kullanılabilir.

CRDR these fans are used in the ventilation for closed areas and can work trouble-free with high-performance. They can work quietly with their outboard rotors.

MATERIAL

Body; The radial fan is made up of a powder-coated galvanized sheets in a recurved fin structure.

SPEED CONTROL

It can be supplied with an optional control device.

USAGE AREAS

It can be used in industrial and constructional applications, factories, kitchens, labs, range hoods, offices, laboratories, malls, restaurants, theaters, flats, nightclubs, chicken farms, etc.

Tip/Kod Type/Code	Elektrik Motoru / Electrical Motor			Max. Debi Air Flow (m ³ / h)
	Voltaj Voltage	Güç Power	Devir Speed	
	(V)	(W)	(d/d) (rpm)	
CRDR-250-M-2K	220	0,17	2.635	1.300
CRDR-315-M-2K	220	0,21	2.660	1.800
CRDR-355-M-4K	220	0,26	1.350	2.750
CRDR-400-M-4K	220	0,43	1.380	3.620
CRDR-450-M-4K	220	0,60	1.340	5.900
CRDR-500-M-4K	220	0,75	1.400	8.000
CRDR-560-T-4K	380	1,10	1.400	10.000

KAPASİTE TABLOSU / CAPACITY CHART

Tip/Kod Type/Code	Hava Debileri (m ³ /h) / Air Flow (m ³ /h)									
	0 Pa	100 Pa	200 Pa	300 Pa	400 Pa	500 Pa	600 Pa	700 Pa	800 Pa	0 Pa
CRDR-250-M-2K	1.300	1.050	840	620	400	50				
CRDR-315-M-2K	1.800	1.400	700							
CRDR-355-M-4K	2.750	2.150	1.200	200						
CRDR-400-M-4K	3.620	3.500	2.700	2.100	1.300	600				
CRDR-450-M-4K	5.900	4.600	3.750	3.000	2.000	700				
CRDR-500-M-4K	8.000	6.600	5.400	4.600	3.600	2.750	1.400	300		
CRDR-560-T-4K	10.000	8.800	8.100	6.100	5.500	4.800	3.600	2.400	1.000	

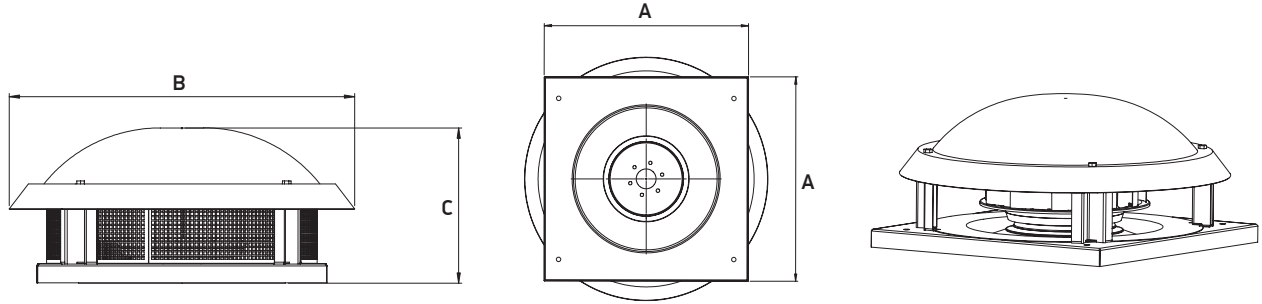

TEKNİK ÖLÇÜLER / TECHNICAL DIMENSION

Tip/Kod Type/Code	Ölçüler / Sizes (mm)		
	A	B	C
CRDR-250-M-2K	370	386	225
CRDR-315-M-2K	454	443	293
CRDR-355-M-4K	595	595	285
CRDR-400-M-4K	595	685	355
CRDR-450-M-4K	664	685	400
CRDR-500-M-4K	798	824	385
CRDR-560-T-4K	798	824	400

TEKNİK ÖLÇÜLER / TECHNICAL DIMENSION

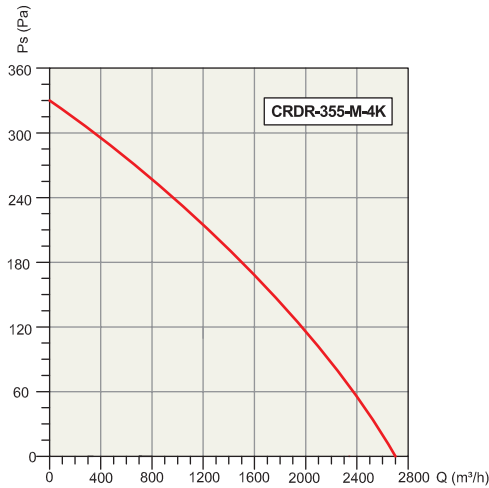
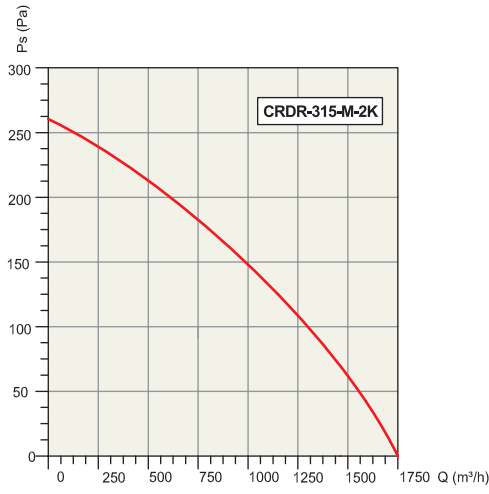
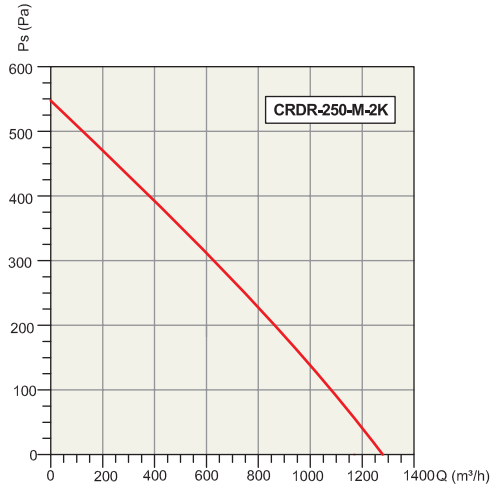

Discover the potential

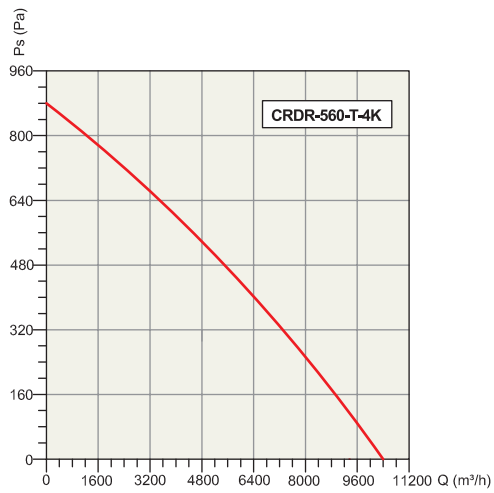
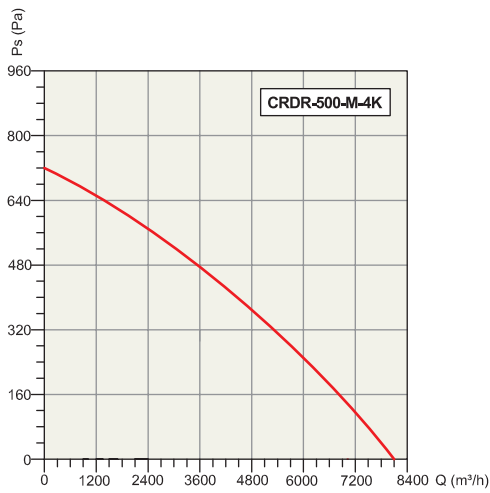
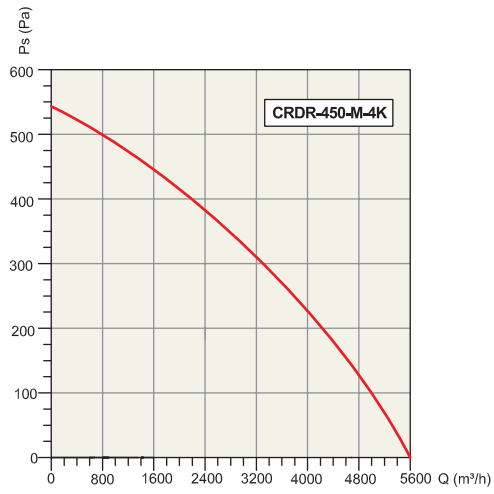
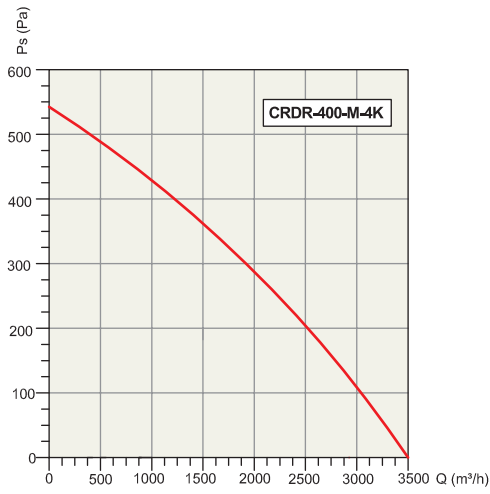

ACTIVENT®

Halkalı Merkez Mahallesi
Şehit Yılmaz Özdemir Caddesi
Sanayi Sokak No: 4
Küçükçekmece, İstanbul, Türkiye

P: +90.212 698 02 25

P: +90.212 698 02 26

P: +90.212 565 73 03

info@activent.com.tr

www.activent.com.tr

