

GÜÇLÜ BİR GELECEK İÇİN STRONGER FOR THE FUTURE



www.activent.com.tr



ACTIVENT®

ÜRÜN KATALOĞU
PRODUCT CATALOGUE



AKPP

PLASTİK PERVANELİ
DİREKT AKUPLE, KOVANLI

PLASTIC PROPELLER AXIAL FAN

AKPP yüksek hava debileri ve yüksek basınç kayıplarını karşılayabilen bu kovanlı fanların pervaneleri PVC hammaddedendir ve kanat açıları ayarlanarak debi ve basınç değişimi yapılabilme şansı sağlarlar.

MALZEME

Gövdesi standart olarak ST-37.2 çelik sacdan elektrostatik boyalı imal edilir. İsteğe göre ayaklı olarak da imal edilebilir. Pervane; özel alaşımlı kompozit PVC malzemeli çift yönlü ve açıları ayarlanabilir olarak imal edilir.

HIZ KONTROLÜ

Opsiyonel olarak frekans inverteri ile sağlanabilirler.

KULLANIM ALANLARI

Kanal uygulamalarında hat ortası ve sonunda tercih edilmekle beraber, teknik, endüstriyel ve dökümhanelerde ve çimento, kağıt, kereste fabrikalarında, soğutma kulelerinde vb. yerlerde kullanılabilir.

AKPP propellers of these barrel fans that can provide high airflow and high-pressure loss are made from PVC materials and it can adjust blade angles and provides flow and pressure change opportunity.

MATERIAL

The body is produced with electrostatic paint of ST-37.2 steel plate as a standard. As per request, it can also be made with a stand. The fan; is manufactured bi-directional with adjustable angles with special alloy composite PVC material.

SPEED CONTROL

Optionally with frequency inverter they can be provided.

USAGE AREAS

They are preferred in the center and end of the line for channel applications, and can also be used in technical, industrial locations and locations like foundries, cement plants, paper mills, saw mills, cooling towers, etc.

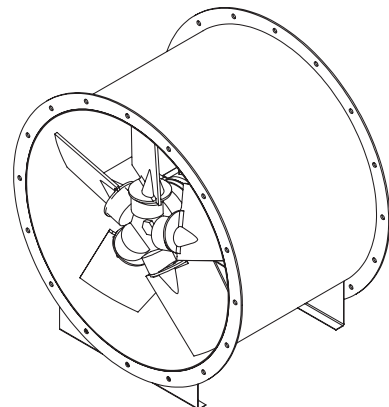
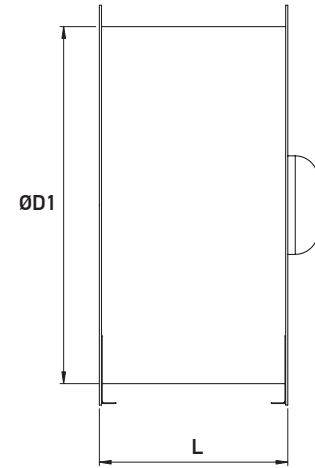
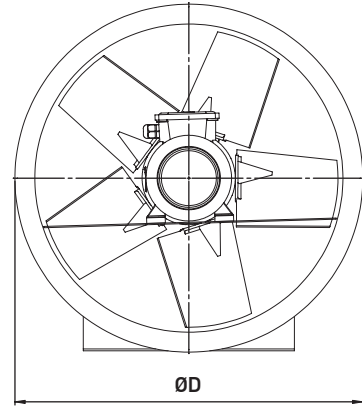



Tip/Kod Type/Code	Elektrik Motoru / Electrical Motor				Max. Debi Air Flow (m ³ / h)
	Voltaj Voltage	Güç Power		Devir Speed	
	(V)	(HP)	(kW)	(d/d) (rpm)	
AKPP-300-0,50-T-4K	380	0,50	0,37	1.380	3.000
AKPP-350-0,50-T-4K	380	0,50	0,37	1.380	3.500
AKPP-400-0,50-T-4K	380	0,50	0,37	1.380	4.500
AKPP-400-0,75-T-4K	380	0,75	0,55	1.380	5.000
AKPP-450-0,50-T-4K	380	0,50	0,37	1.380	6.000
AKPP-450-0,75-T-4K	380	0,75	0,55	1.380	6.500
AKPP-500-0,75-T-4K	380	0,75	0,55	1.380	8.000
AKPP-500-1,00-T-4K	380	1,00	0,75	1.380	9.500
AKPP-560-1,00-T-4K	380	1,00	0,75	1.410	9.600
AKPP-560-1,50-T-4K	380	1,50	1,10	1.410	12.000
AKPP-630-1,50-T-4K	380	1,50	1,10	1.410	12.250
AKPP-630-2,00-T-4K	380	2,00	1,50	1.430	14.500
AKPP-710-2,00-T-4K	380	2,00	1,50	1.430	16.000
AKPP-710-4,00-T-4K	380	4,00	3,00	1.435	22.000
AKPP-800-4,00-T-4K	380	4,00	3,00	1.435	23.500
AKPP-800-7,50-T-4K	380	7,50	5,50	1.455	34.000
AKPP-900-5,50-T-4K	380	5,50	4,00	1.455	27.500
AKPP-900-10,0-T-4K	380	10,0	7,50	1.465	40.000
AKPP-1000-10,0-T-4K	380	10,0	7,50	1.465	43.000
AKPP-1000-15,0-T-4K	380	15,0	11,0	1.470	53.000
AKPP-1100-15,0-T-4K	380	15,0	11,0	1.470	65.000
AKPP-1100-20,0-T-4K	380	20,0	15,0	1.470	77.000
AKPP-1200-25,0-T-4K	380	25,0	18,5	1.470	95.000
AKPP-1200-30,0-T-4K	380	30,0	22,0	1.470	100.000

TEKNİK ÖLÇÜLER / TECHNICAL DIMENSION

Tip/Kod Type/Code	Ölçüler / Sizes (mm)		
	D	D1	L
AKPP-300-0,50-T-4K	300	370	300
AKPP-350-0,50-T-4K	350	420	325
AKPP-400-0,50-T-4K	400	470	350
AKPP-400-0,75-T-4K	400	470	350
AKPP-450-0,50-T-4K	450	520	400
AKPP-450-0,75-T-4K	450	520	400
AKPP-500-0,75-T-4K	500	570	400
AKPP-500-1,00-T-4K	500	570	400
AKPP-560-1,00-T-4K	560	630	450
AKPP-560-1,50-T-4K	560	630	450
AKPP-630-1,50-T-4K	630	700	475
AKPP-630-2,00-T-4K	630	700	475

Tip/Kod Type/Code	Ölçüler / Sizes (mm)		
	D	D1	L
AKPP-710-2,00-T-4K	710	780	525
AKPP-710-4,00-T-4K	710	780	525
AKPP-800-4,00-T-4K	800	870	550
AKPP-800-7,50-T-4K	800	870	550
AKPP-900-5,50-T-4K	900	970	600
AKPP-900-10,0-T-4K	900	970	600
AKPP-1000-10,0-T-4K	1.000	1.100	600
AKPP-1000-15,0-T-4K	1.000	1.100	600
AKPP-1100-15,0-T-4K	1.100	1.200	700
AKPP-1100-20,0-T-4K	1.100	1.200	700
AKPP-1200-25,0-T-4K	1.200	1.300	750
AKPP-1200-30,0-T-4K	1.200	1.300	750

TEKNİK ÖLÇÜLER / TECHNICAL DIMENSION

AKPP-300-0,50-T-4K

1500 RPM

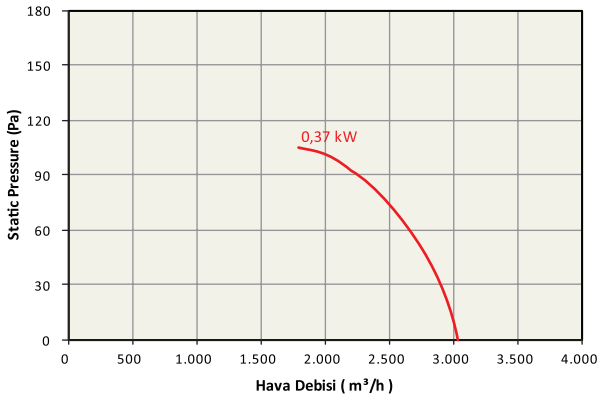

AKPP-350-0,50-T-4K

1500 RPM

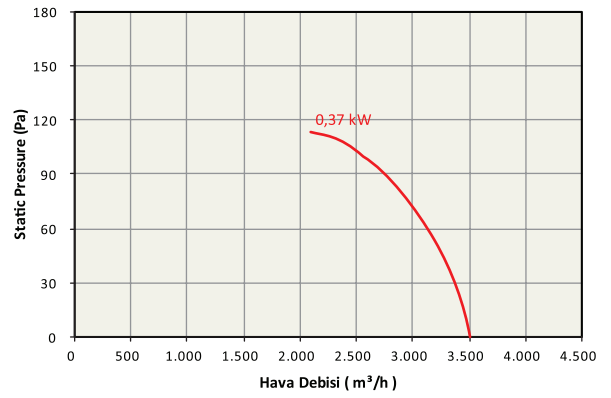

**[1]: AKPP-400-0,50-T-4K
[2]: AKPP-400-0,75-T-4K**

1500 RPM

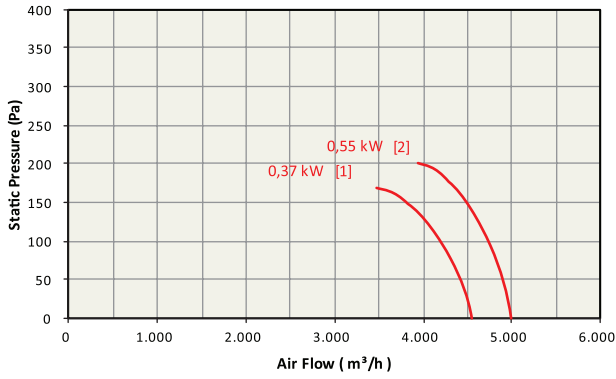

**[1]: AKPP-450-0,50-T-4K
[2]: AKPP-450-0,75-T-4K**

1500 RPM

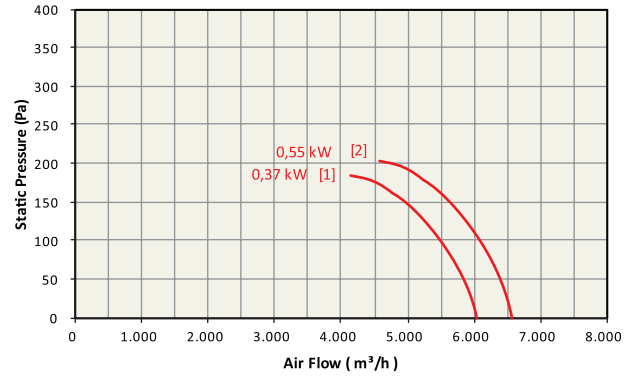

**[1]: AKPP-500-0,75-T-4K
[2]: AKPP-500-1,00-T-4K**

1500 RPM

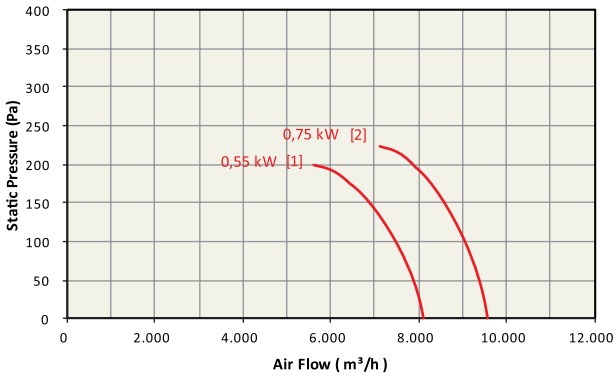



[1]: AKPP-560-1,00-T-4K [2]: AKPP-560-1,50-T-4K [3]: AKPP-560-2,00-T-4K [4]: AKPP-560-3,00-T-4K

1500 RPM

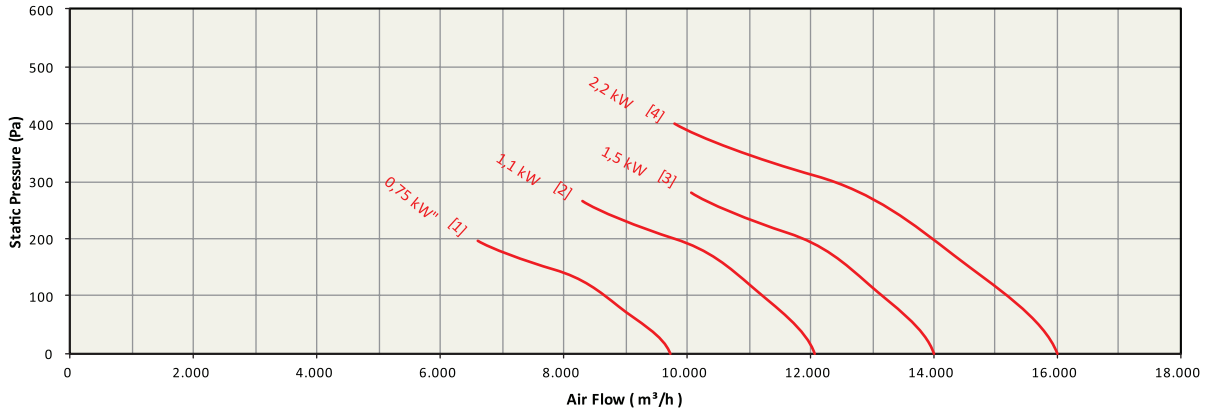

[1]: AKPP-630-1,00-T-4K [2]: AKPP-630-1,50-T-4K [3]: AKPP-630-2,00-T-4K [4]: AKPP-630-3,00-T-4K

1500 RPM

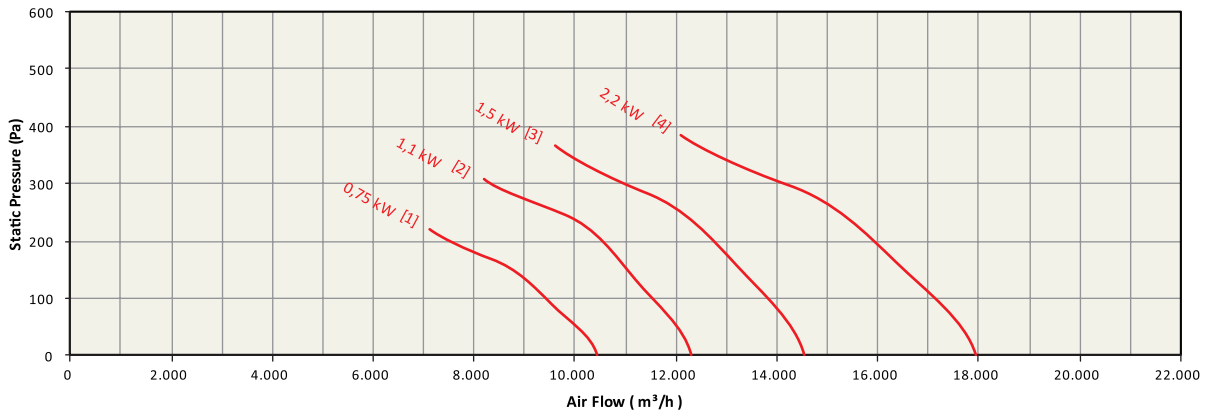

[1]: AKPP-710-2,00-T-4K [2]: AKPP-710-3,00-T-4K [3]: AKPP-710-4,00-T-4K [4]: AKPP-710-5,50-T-4K [5]: AKPP-710-7,50-T-4K

1500 RPM

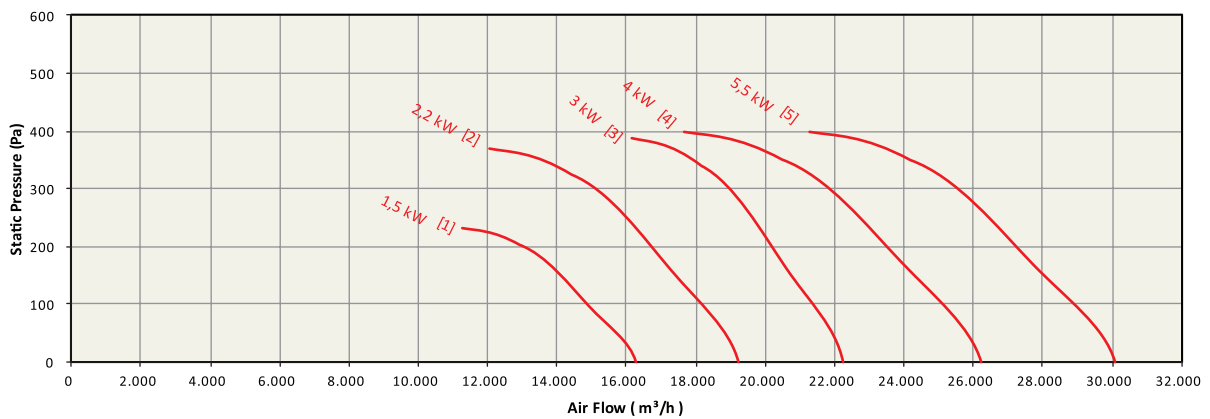

4 AKSİYAL FANLAR AXIAL FANS



TSEK

TSE

K-Q
TSE-800-M
9000

CE

[1]: AKPP-800-4,00-T-4K [2]: AKPP-800-5,50-T-4K [3]: AKPP-800-7,50-T-4K [4]: AKPP-800-10,00-T-4K

1500 RPM

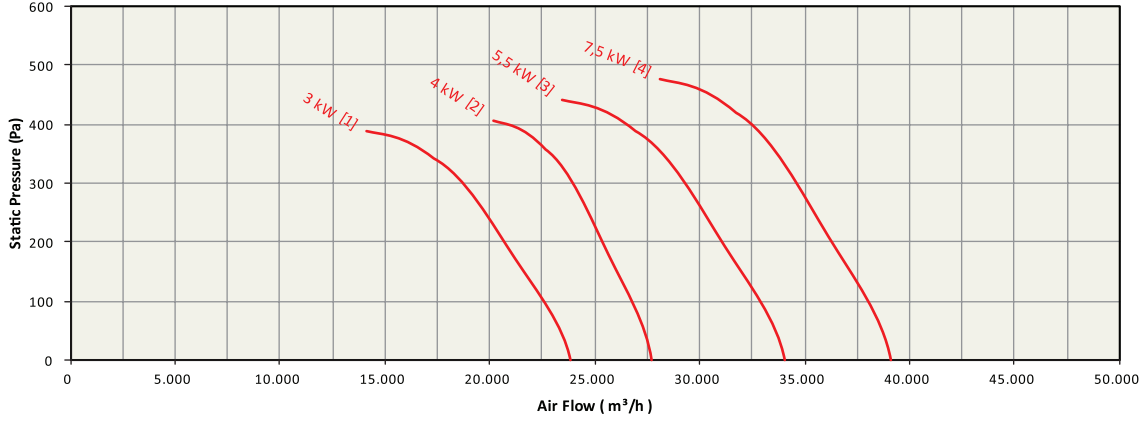

[1]: AKPP-900-5,50-T-4K [2]: AKPP-900-10,00-T-4K [3]: AKPP-900-15,0-T-4K [4]: AKPP-900-20,00-T-4K

1500 RPM

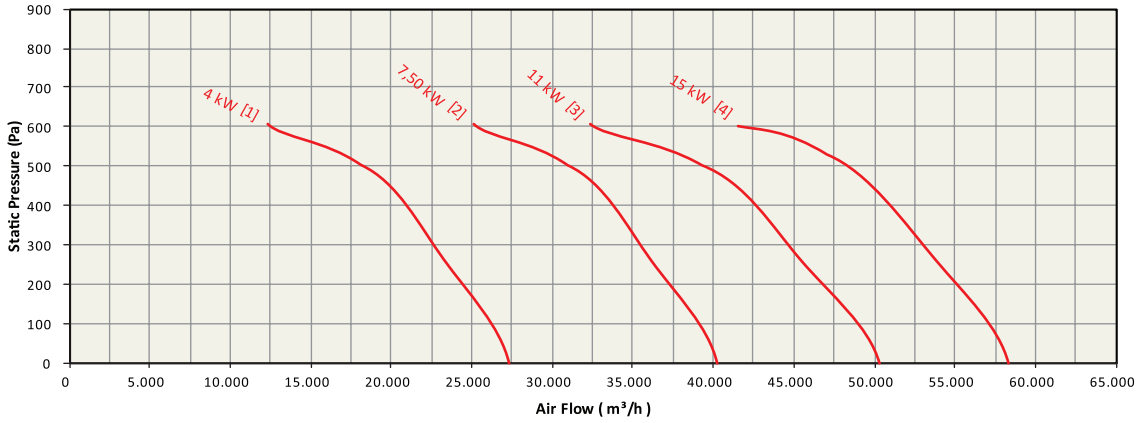

[1]: AKPP-1000-10,00-T-4K [2]: AKPP-1000-15,00-T-4K [3]: AKPP-1000-20,0-T-4K [4]: AKPP-1000-25,00-T-4K
[4]: AKPP-1000-30,00-T-4K [4]: AKPP-1000-40,00-T-4K [4]: AKPP-1000-50,00-T-4K

1500 RPM

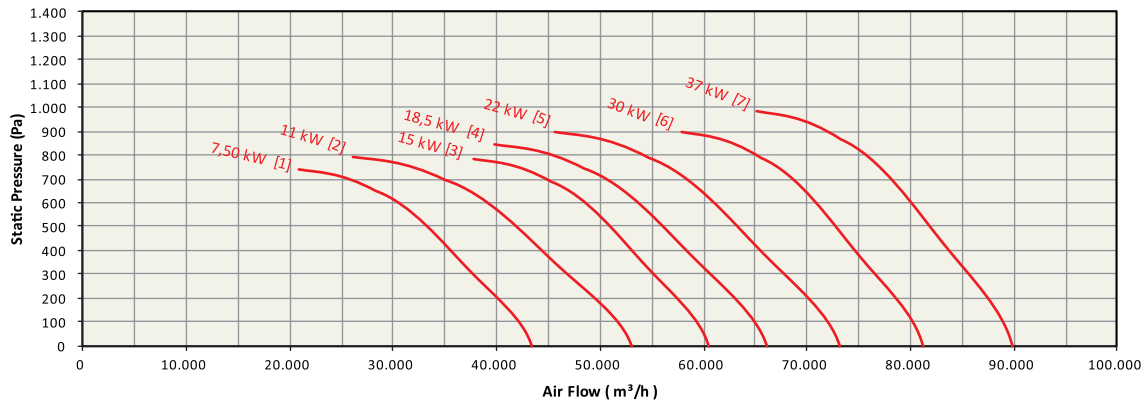



[1]: AKPP-1100-15,0-T-4K [2]: AKPP-1100-20,0-T-4K [3]: AKPP-1100-30,0-T-4K
[4]: AKPP-1100-40,0-T-4K [5]: AKPP-1100-50,0-T-4K [6]: AKPP-1100-60,0-T-4K

1500 RPM

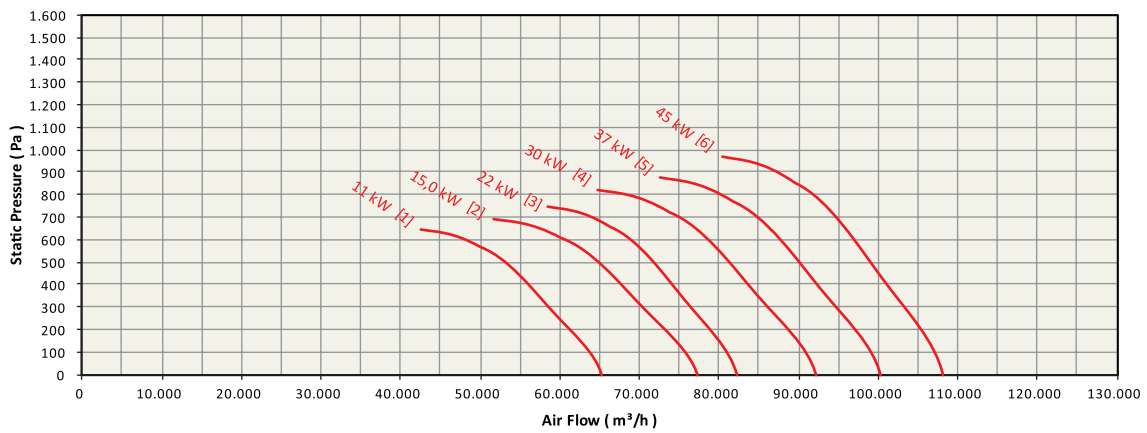

[1]: AKPP-1200-25,0-T-4K [2]: AKPP-1200-30,0-T-4K [3]: AKPP-1200-40,0-T-4K [4]: AKPP-1200-50,0-T-4K
[5]: AKPP-1200-60,0-T-4K [6]: AKPP-1200-75,0-T-4K [7]: AKPP-1200-100,0-T-4K

1500 RPM

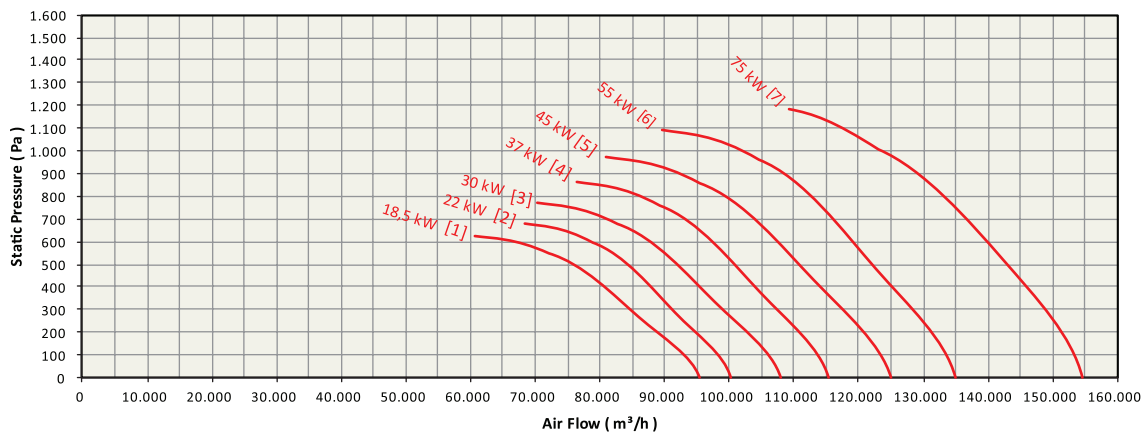

ACTIVENT®

Halkalı Merkez Mahallesi
Şehit Yılmaz Özdemir Caddesi
Sanayi Sokak No: 4
Küçükçekmece, İstanbul, Türkiye

P: +90.212 698 02 25

P: +90.212 698 02 26

P: +90.212 565 73 03

info@activent.com.tr

www.activent.com.tr

