

GÜÇLÜ BİR GELECEK İÇİN STRONGER FOR THE FUTURE



www.activent.com.tr



ACTIVENT®

ÜRÜN KATALOĞU
PRODUCT CATALOGUE

5 ÇATI TİPİ FANLAR ROOF TYPE FANS

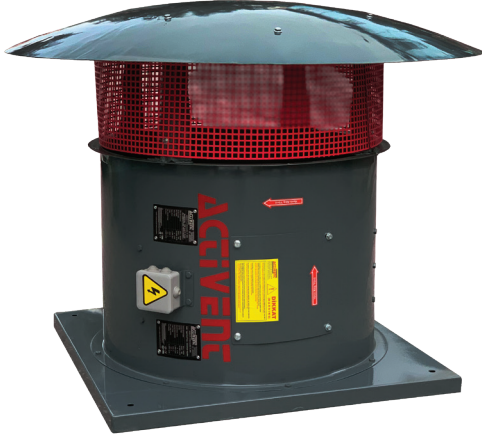

AKAP-R

AKSİYEL TİPİ ÇATI FANI
AXIAL TYPE ROOF FAN

AKAP-R eksenel çatı fanları basınçlandırma fanında kullanılır, temiz hava fanı ve duman egzoz fanı uygulamalarında ve yangına dayanıklıdır, gürültü standardına uygun olarak tasarlanmıştır. Duman tahliyesi fanlar yangına dayanıklıdır.

MALZEME

Fan gövdesi çelik sacdır. Pervane ısıya dayanımlı alüminyumdan üretilmiştir.

HIZ KONTROLÜ

Opsiyonel olarak frekans inverteri ile sağlanabilir.

KULLANIM ALANLARI

Çatı tipi aksiyel fanlar basınçlandırma fanı, taze hava fanı ve duman egzoz fanı uygulamalarında kullanılır.

AKAP-R axial roof fans are used in pressurization fan, in the applications of clean air fan and smoke exhaust fan, and fire resistant, designed in accordance with noise standard Jul. Smoke drain fans are fire resistant.

MATERIAL

The Fan body is steel sheet. The propeller is made of heat resistant aluminum.

SPEED CONTROL

It can be supplied with optional frequency inverters.

USAGE AREAS

Roof type axial fans pressurization fan, fresh air fan and smoke exhaust fan applications is used.

| Tip/Kod Type/Code | Elektrik Motoru / Electrical Motor | | | | Max. Debi Air Flow (m ³ / h) |
|-----------------------|------------------------------------|--------------|-------|----------------|---|
| | Voltaj Voltage | Güç Power | | Devir Speed | |
| | (V) | (HP) | (kW) | (d/d) (rpm) | |
| AKAP-R-400-1,00-T-2K | 380 | 1,00 | 0,75 | 2.860 | 3.600 |
| AKAP-R-450-2,00-T-2K | 380 | 2,00 | 1,50 | 2.900 | 6.250 |
| AKAP-R-500-1,00-T-4K | 380 | 1,00 | 0,75 | 1.410 | 10.300 |
| AKAP-R-560-1,50-T-4K | 380 | 1,50 | 1,10 | 1.430 | 13.000 |
| AKAP-R-630-2,00-T-4K | 380 | 2,00 | 1,50 | 1.430 | 18.500 |
| AKAP-R-710-5,50-T-4K | 380 | 5,50 | 4,00 | 1.455 | 31.500 |
| AKAP-R-800-10,0-T-4K | 380 | 10,0 | 7,50 | 1.465 | 42.500 |
| AKAP-R-900-20,0-T-4K | 380 | 20,0 | 15,00 | 1.470 | 61.000 |
| AKAP-R-1000-20,0-T-4K | 380 | 20,0 | 15,00 | 1.470 | 77.000 |
| AKAP-R-1100-25,0-T-4K | 380 | 25,0 | 18,50 | 1.475 | 83.000 |
| AKAP-R-1200-40,0-T-4K | 380 | 40,0 | 30,00 | 1.475 | 115.000 |

TEKNİK ÖLÇÜLER / TECHNICAL DIMENSION

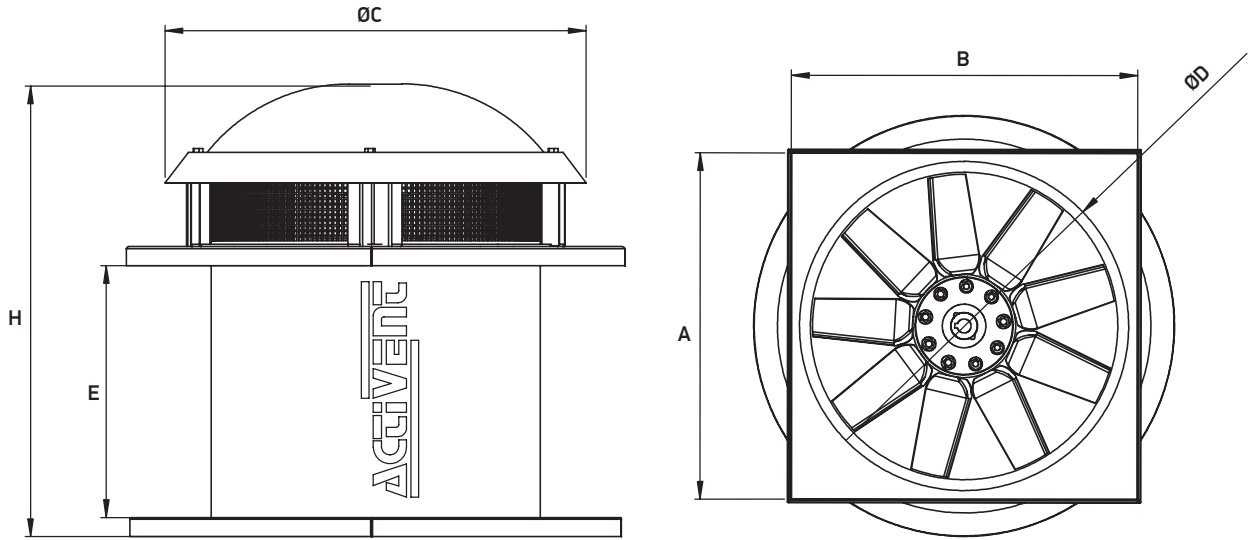

| Tip/Kod Type/Code | Ölçüler / Sizes (mm) | | | | | |
|-----------------------|----------------------|-------|-------|-------|-----|-------|
| | A | B | ØC | ØD | E | H |
| AKAP-R-400-1,00-T-2K | 630 | 630 | 700 | 400 | 470 | 880 |
| AKAP-R-450-2,00-T-2K | 710 | 710 | 700 | 450 | 470 | 880 |
| AKAP-R-500-1,00-T-4K | 740 | 740 | 840 | 500 | 580 | 1.030 |
| AKAP-R-560-1,50-T-4K | 800 | 800 | 1.150 | 560 | 580 | 1.030 |
| AKAP-R-630-2,00-T-4K | 850 | 850 | 1.150 | 630 | 600 | 1.160 |
| AKAP-R-710-5,50-T-4K | 850 | 850 | 1.150 | 710 | 700 | 1.300 |
| AKAP-R-800-10,0-T-4K | 920 | 920 | 1.150 | 800 | 775 | 1.300 |
| AKAP-R-900-20,0-T-4K | 1.000 | 1.000 | 1.150 | 900 | 775 | 1.375 |
| AKAP-R-1000-20,0-T-4K | 1.100 | 1.100 | 1.450 | 1.000 | 850 | 1.450 |
| AKAP-R-1100-25,0-T-4K | 1.130 | 1.130 | 1.450 | 1.100 | 850 | 1.450 |
| AKAP-R-1200-40,0-T-4K | 1.430 | 1.430 | 1.450 | 1.200 | 950 | 1.550 |

TEKNİK ÖLÇÜLER / TECHNICAL DIMENSION

AKAP-R-400-1,00-T-2K

3000 RPM

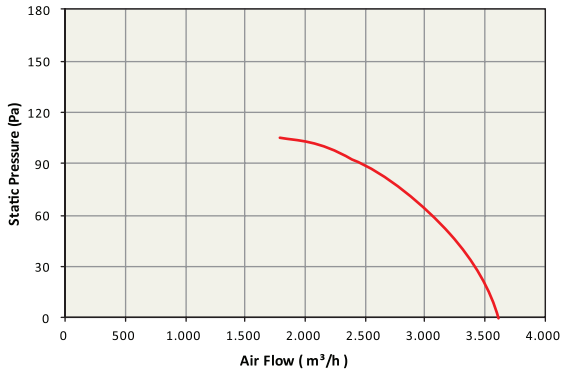

AKAP-R-450-2,00-T-2K

3000 RPM

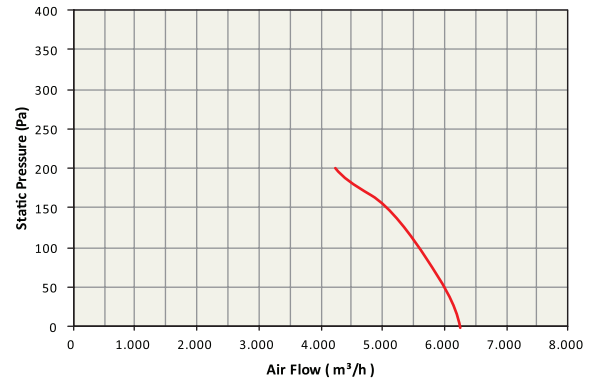

AKAP-R-500-1,00-T-4K

1500 RPM

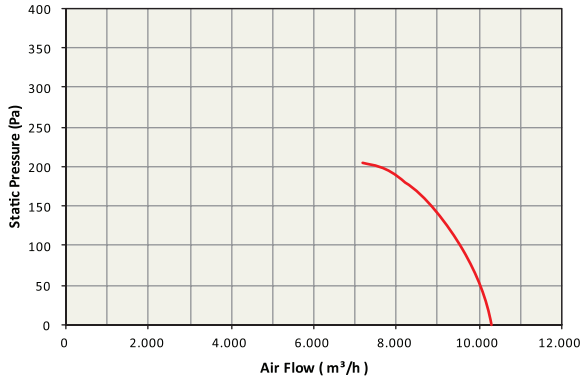

AKAP-R-560-1,50-T-4K

1500 RPM

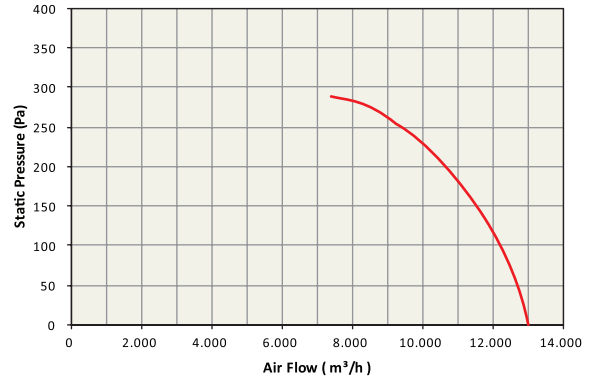

AKAP-R-630-2,00-T-4K

1500 RPM

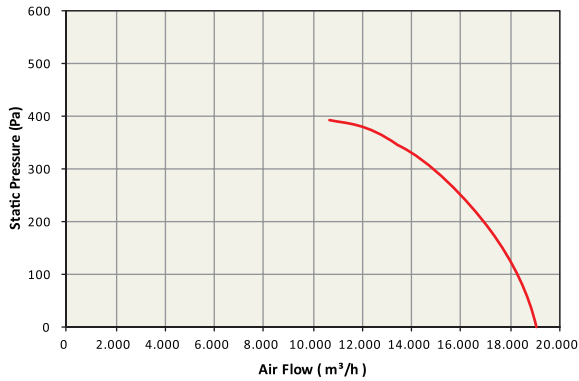

AKAP-R-710-5,50-T-4K

1500 RPM

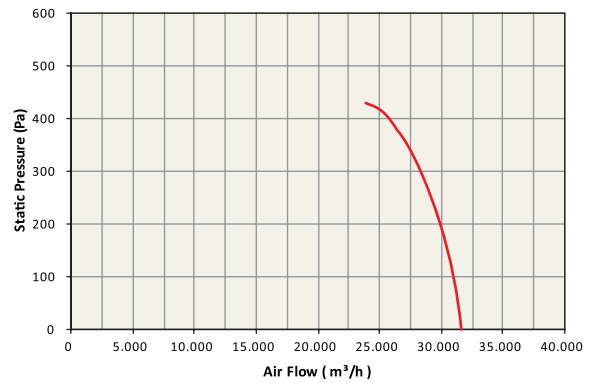

Discover the potential



AKAP-R-800-10,0-T- 4K

1500R PM

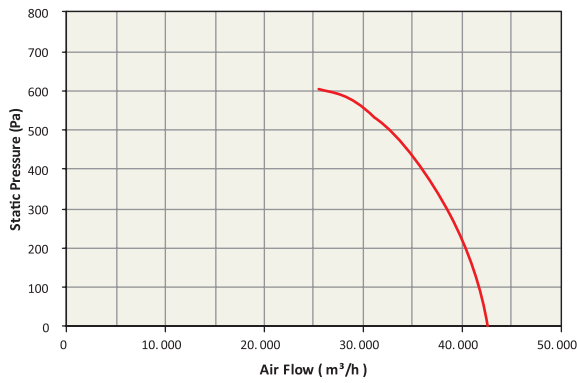

AKAP-R-900-20,0-T- 4K

1500R PM

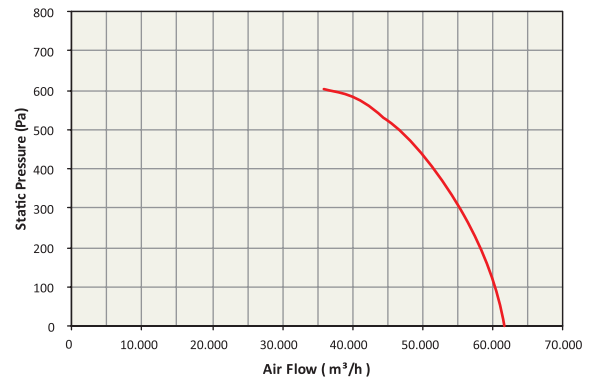

AKAP-R-1000-20,0-T- 4K

1500R PM

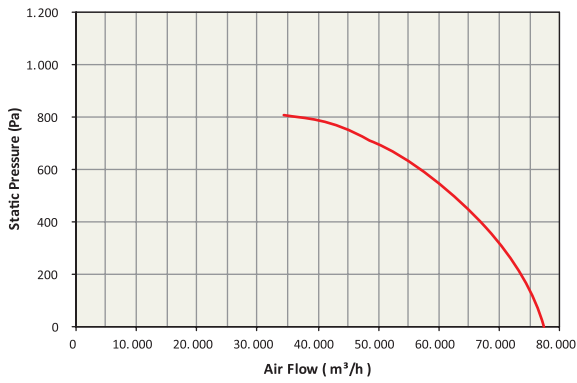

AKAP-R-1100-25,0-T- 4K

1500R PM

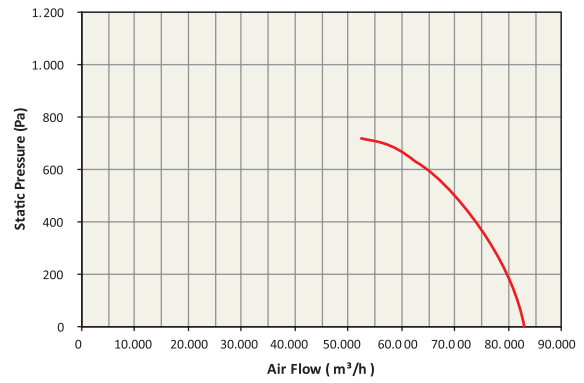

AKAP-R-1200-40,0-T- 4K

1500R PM

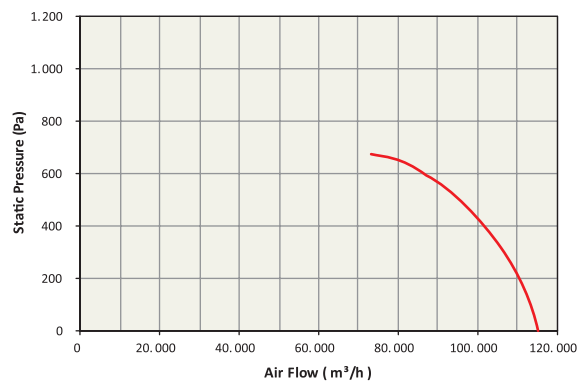

ACTIVENT®

Halkalı Merkez Mahallesi
Şehit Yılmaz Özdemir Caddesi
Sanayi Sokak No: 4
Küçükçekmece, İstanbul, Türkiye

P: +90.212 698 02 25

P: +90.212 698 02 26

P: +90.212 565 73 03

info@activent.com.tr

www.activent.com.tr

