

GÜÇLÜ BİR GELECEK İÇİN STRONGER FOR THE FUTURE



www.activent.com.tr



ACTIVENT®

ÜRÜN KATALOĞU
PRODUCT CATALOGUE

4 AKSİYAL FANLAR AXIAL FANS



ADMP

4 KANATLI METAL PERVELİ
DİREKT AKUPLE MOTORLU KARE KASALI

4 WING METAL PROPELLER SQUARE
FRAME FANS

ADMP duvar ve pencereye montaj imkanı olan bu fanlar güçlü hava akımı sağlarlar. Düşük ses seviyeleri ve yüksek verimleri ile ekonomik fanlardır.

MALZEME

Gövdesi ve pervanesi elektrostatik toz boyalı sacdan mamuldür.

HIZ KONTROLÜ

Opsiyonel olarak frekans inverteri ile sağlanabilir.

KULLANIM ALANLARI

Fabrikalar, depolar, boyahaneler, imalathaneler vb. büyük hacimli yerlerin havalandırılması için kullanılır.

ADMP these fans which can be mounted on the walls and windows provide a strong air flow. They are economic fans with low sound levels and a high productivity.

MATERIAL

Its body and fan are made of electrostatic powder-coated steel plate.

SPEED CONTROL

It can be supplied with optional frequency inverters.

USAGE AREAS

It is used for the ventilation of large volume locations like factories, warehouses, paint shops, workshops, etc.

Tip/Kod Type/Code	Elektrik Motoru / Electrical Motor				Max. Debi Air Flow (m ³ / h)
	Voltaj Voltage	Güç Power		Devir Speed	
	(V)	(HP)	(kW)	(d/d) (rpm)	
ADMP-300-0,50-T-4K	380	0,50	0,37	1.380	3.500
ADMP-350-0,50-T-4K	380	0,50	0,37	1.380	4.000
ADMP-400-0,50-T-4K	380	0,50	0,37	1.380	5.000
ADMP-450-0,50-T-4K	380	0,50	0,37	1.380	6.000
ADMP-500-1,00-T-4K	380	1,00	0,75	1.410	8.000
ADMP-550-1,00-T-4K	380	1,00	0,75	1.410	10.000
ADMP-600-1,50-T-4K	380	1,50	1,10	1.430	12.000
ADMP-650-2,00-T-4K	380	2,00	1,50	1.430	14.000
ADMP-700-3,00-T-4K	380	3,00	2,20	1.435	16.000
ADMP-750-4,00-T-4K	380	4,00	3,00	1.435	20.000
ADMP-800-5,50-T-4K	380	5,50	4,00	1.455	25.000
ADMP-900-7,50-T-4K	380	7,50	5,50	1.465	35.000
ADMP-1000-7,50-T-6K	380	7,50	5,50	960	40.000
ADMP-1100-7,50-T-6K	380	7,50	5,50	960	45.000
ADMP-1200-10,0-T-6K	380	10,0	7,50	960	50.000

TEKNİK ÖLÇÜLER / TECHNICAL DIMENSION

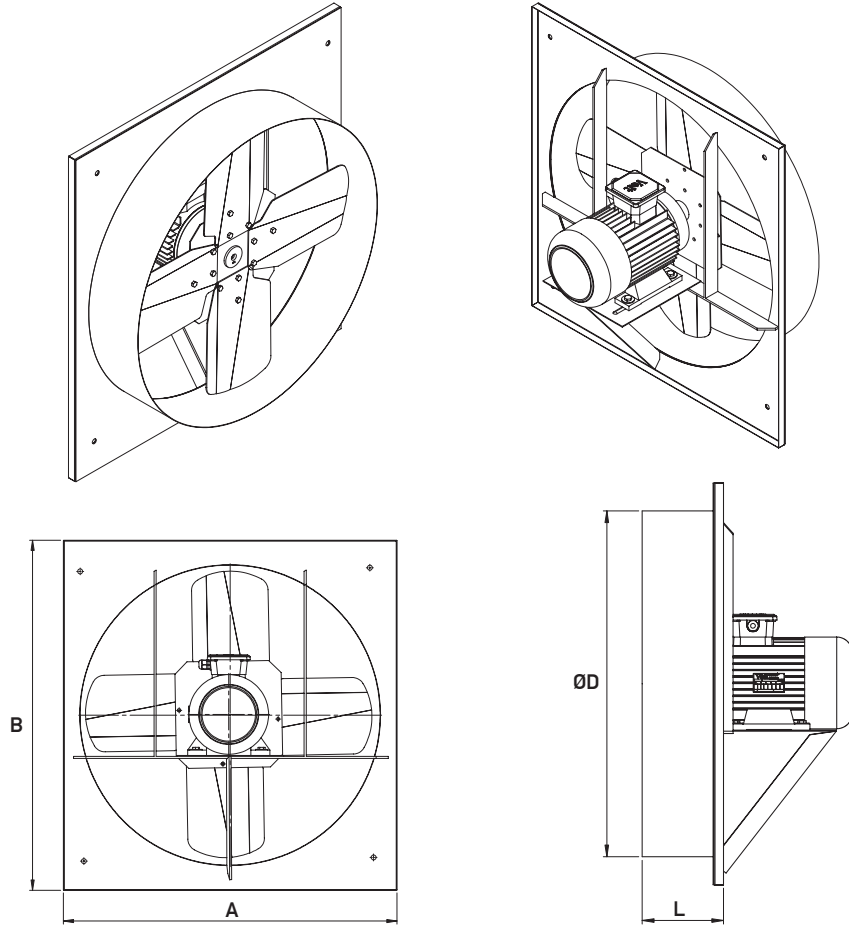

Tip/Kod Type/Code	Ölçüler / Sizes (mm)		
	AxB	ØD	L
ADMP-300-0,50-T-4K	450	300	130
ADMP-350-0,50-T-4K	500	350	130
ADMP-400-0,50-T-4K	550	400	130
ADMP-450-0,50-T-4K	600	450	130
ADMP-500-1,00-T-4K	650	500	150
ADMP-550-1,00-T-4K	700	550	150
ADMP-600-1,50-T-4K	750	600	150
ADMP-650-2,00-T-4K	800	650	200
ADMP-700-3,00-T-4K	850	700	200
ADMP-750-4,00-T-4K	900	750	200
ADMP-800-5,50-T-4K	950	800	200
ADMP-900-7,50-T-4K	1.050	900	220
ADMP-1000-7,50-T-6K	1.150	1.000	250
ADMP-1100-7,50-T-6K	1.250	1.100	250
ADMP-1200-10,0-T-6K	1.350	1.200	250

TEKNİK ÖLÇÜLER / TECHNICAL DIMENSION

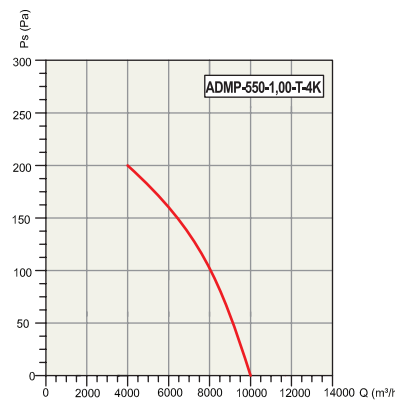
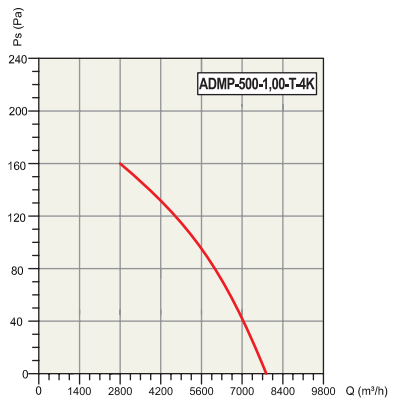
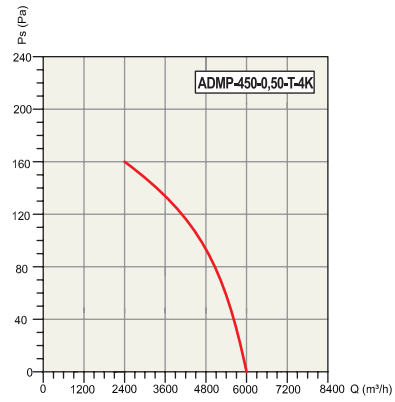
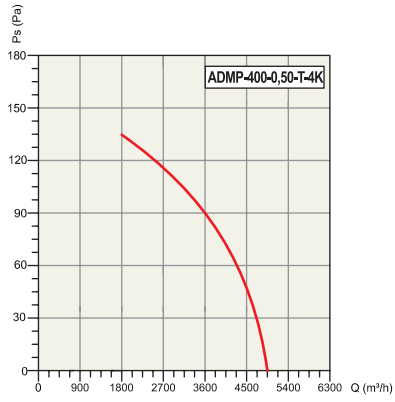
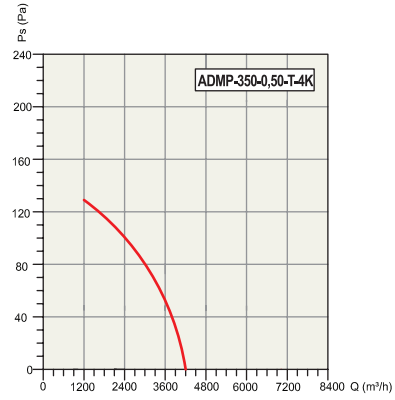
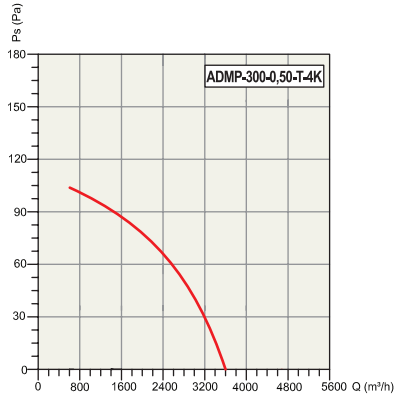

Discover the potential

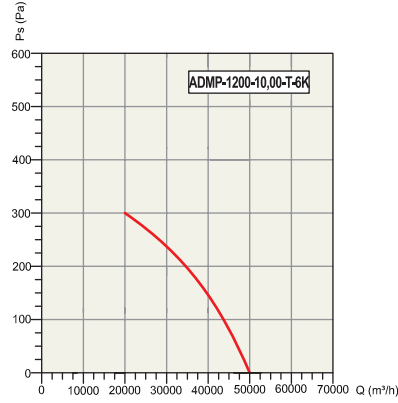
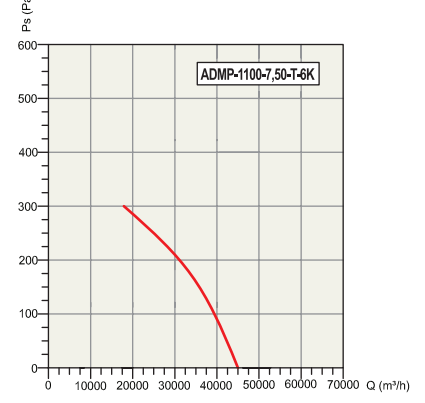
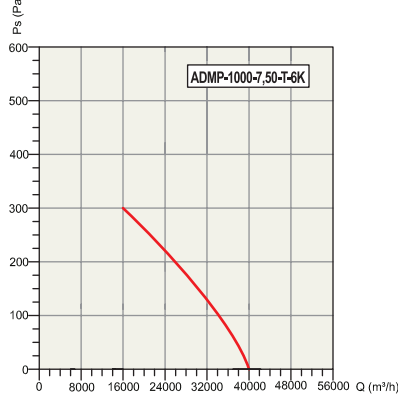
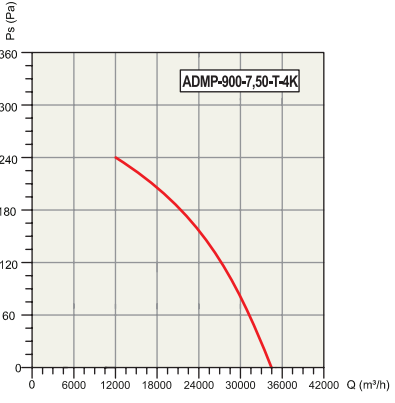
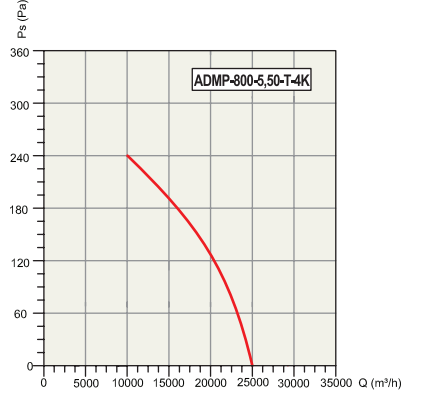
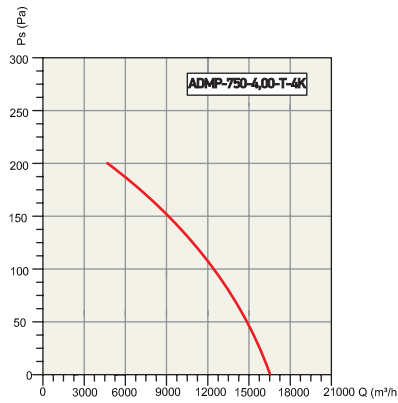
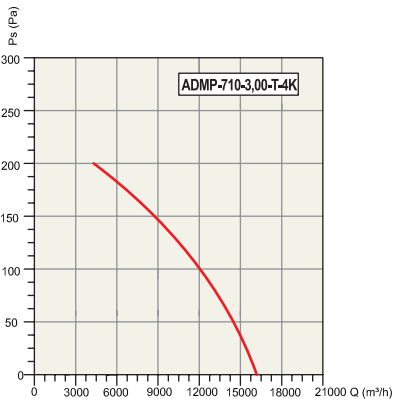
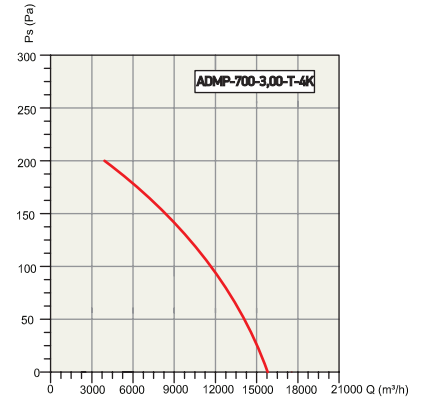
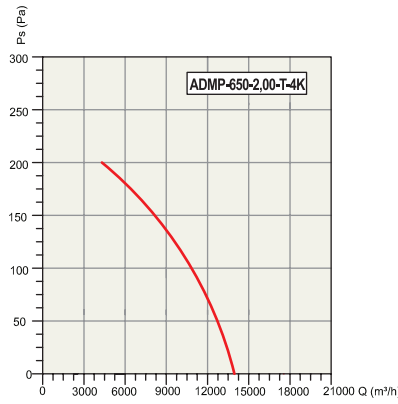
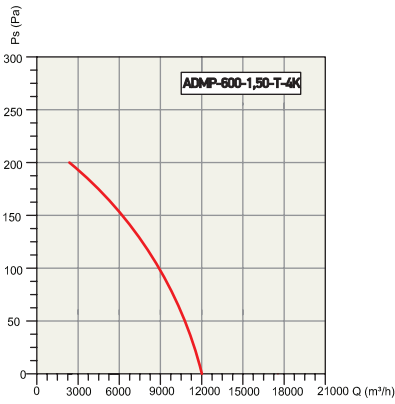

ACTIVENT®

Halkalı Merkez Mahallesi
Şehit Yılmaz Özdemir Caddesi
Sanayi Sokak No: 4
Küçükçekmece, İstanbul, Türkiye

P: +90.212 698 02 25

P: +90.212 698 02 26

P: +90.212 565 73 03

info@activent.com.tr

www.activent.com.tr

