

# GÜÇLÜ BİR GELECEK İÇİN STRONGER FOR THE FUTURE



[www.activent.com.tr](http://www.activent.com.tr)



## ACTIVENT®

ÜRÜN KATALOĞU  
PRODUCT CATALOGUE

# 3 RADYAL FANLAR RADIAL FANS



## ROBT

ÖNE EĞİMLİ ve SIK KANATLI  
TEK EMİŞLİ RADYAL FAN

SINGLE SUCTION FORWARD  
CURVED RADIAL FAN

**ROBT** metal gövdeli direkt akuple fanlardır. Motor hava akımının dışında olmasından dolayı yüksek sıcaklıktaki hava transferlerinde , boyahanelerde ve buharlı ütü makinelerinde kullanılır.

### MALZEME

Gövdesi; Elektrostatik toz boyalı DKP sacdan, pervanesi ise galvaniz sacdan mamüldür. Kanat yapısı öne eğimlidir.

### HIZ KONTROLÜ

Opsiyonel olarak hız anahtarı (monofaze) yada frekans inverteri (trifaze) ile sağlanır.

### KULLANIM ALANLARI

Seralar, fabrikalar, depolar, boyahaneler, buharlı ütü makinelerinde, plastik ve ambalajlama makineleri vb. sıcak ve tozlu havanın sirkülasyonlarında, soğutma sistemlerinde kullanılırlar.

**ROBT** is a direct coupled fan with a metal body. It is used in high temperature air transfers , paint shops and steam ironing machines due to the fact that the engine is out of air flow.

### MATERIAL

Its body is made of electrostatic powder coated DKP sheet, and its propeller is made of galvanized sheet. The wing structure is forward-inclined.

### SPEED CONTROL

As an option, it is provided with a speed switch (monophase) or frequency inverter (Triphase).

### USAGE AREAS

Greenhouses, factories, warehouses, paint shops, steam ironing machines, plastic and packaging machines, etc. they are used in the circulation of hot and dusty air, cooling systems.

Tip/Kod Type/Code	Elektrik Motoru / Electrical Motor			Max. Debi Air Flow m <sup>3</sup> / h
	Voltaj Voltage	Güç Power	Devir Speed	
	(V)	(W)	(d/d) (rpm)	
ROBT-200-T-2K	380	370	2.800	2.150
ROBT-200-T-4K	380	280	1.400	1.050
ROBM-200-M-2K	220	370	2.800	1.850
ROBM-200-M-4K	220	300	1.400	950
ROBM-200-M-2K (SPARSE WING)	220	260	2.800	1.050
ROBT-260-T-2K	380	750	2.800	2.650
ROBT-260-T-4K	380	220	1.400	1.350
ROBM-260-M-2K	220	750	2.800	2.500
ROBM-260-M-4K	220	350	1.400	1.300

TEKNİK ÖLÇÜLER / TECHNICAL DIMENSION

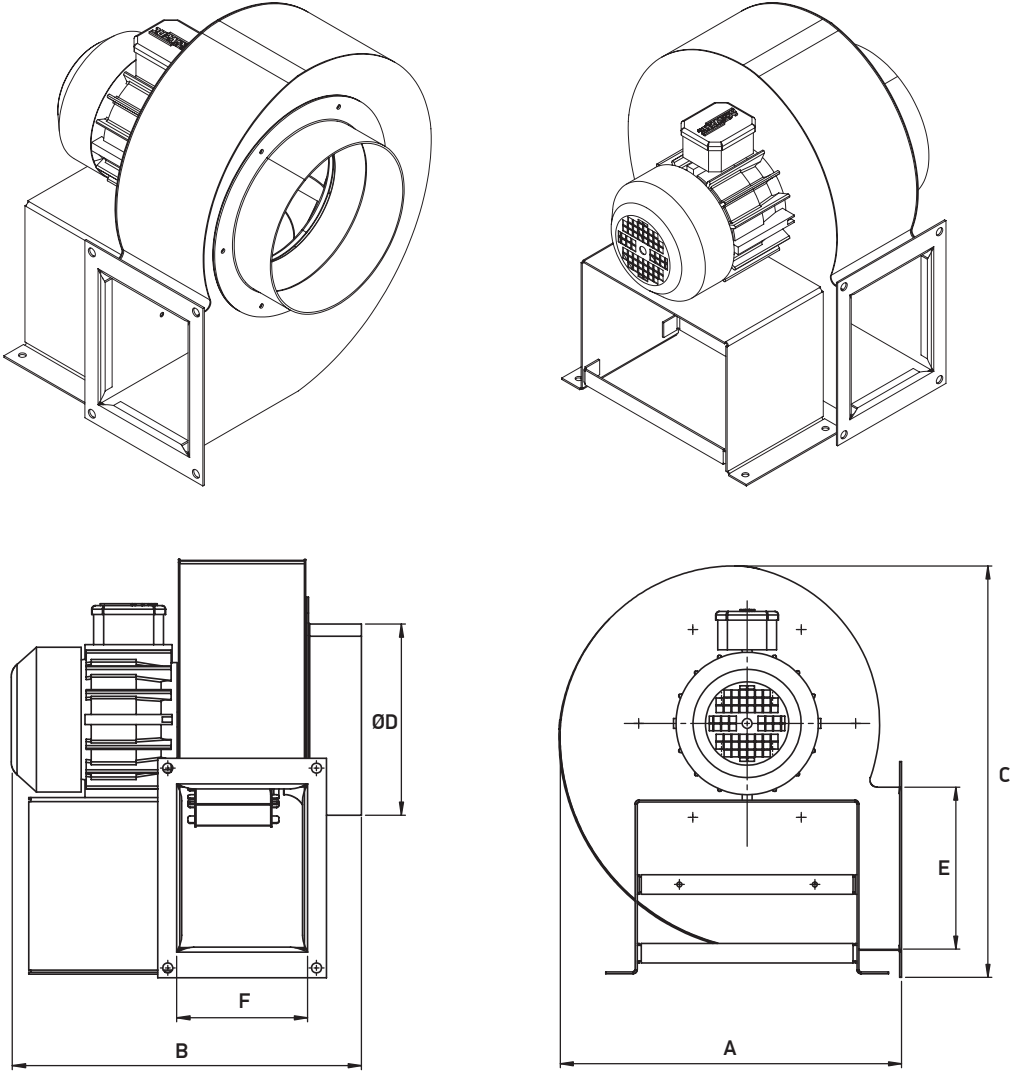

Tip/Kod Type/Code	Ölçüler / Sizes (mm)					
	A	B	C	D	E	F
ROBT-200-T-2K	288	322	315	163	115	102
ROBT-200-T-4K	288	322	315	163	115	102
ROBM-200-M-2K	288	322	315	163	115	102
ROBM-200-M-4K	288	322	315	163	115	102
ROBM-200-M-2K(SPARSE WING)	405	405	360	197	137	115
ROBT-260-T-2K	405	405	360	197	137	115
ROBT-260-T-4K	405	405	360	197	137	115
ROBM-260-M-2K	405	405	360	197	137	115
ROBM-260-M-4K	405	405	360	197	137	115

## TEKNİK ÖLÇÜLER / TECHNICAL DIMENSION

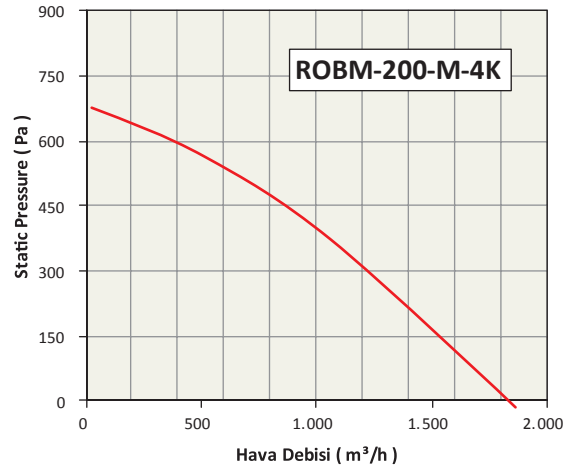
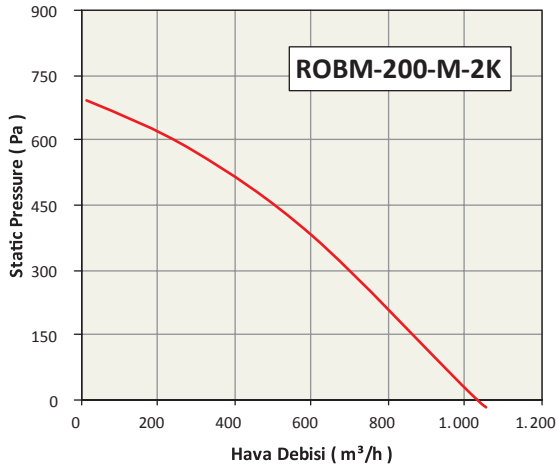
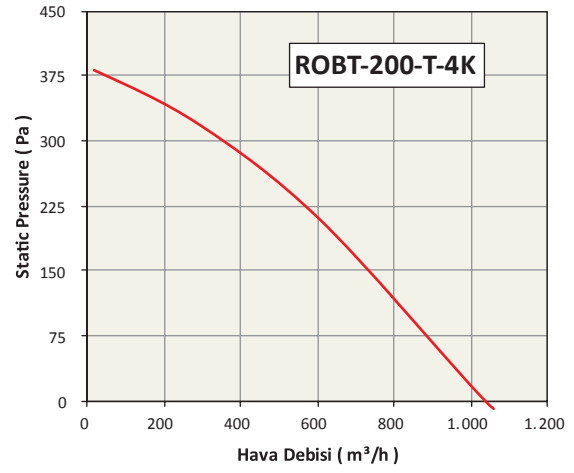
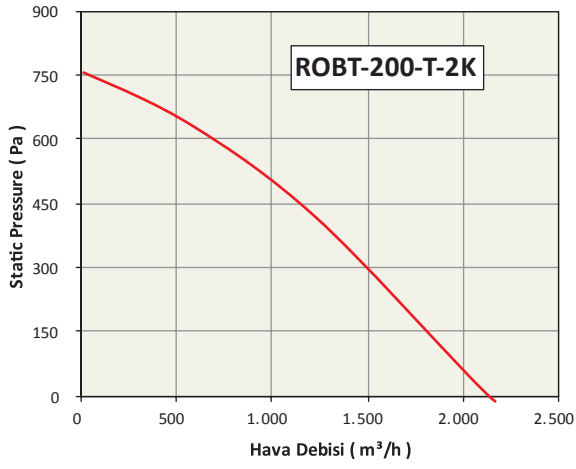



**ROBM-200-M-2K**  
**SEYREK KANAT/SPARSE WING)**

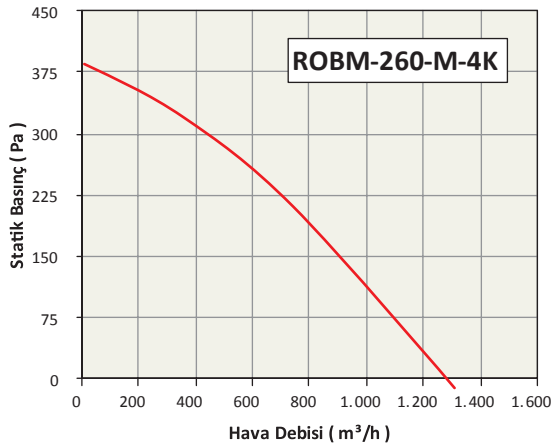
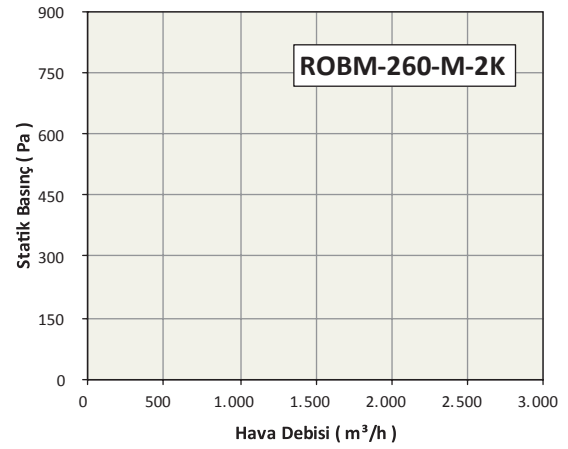
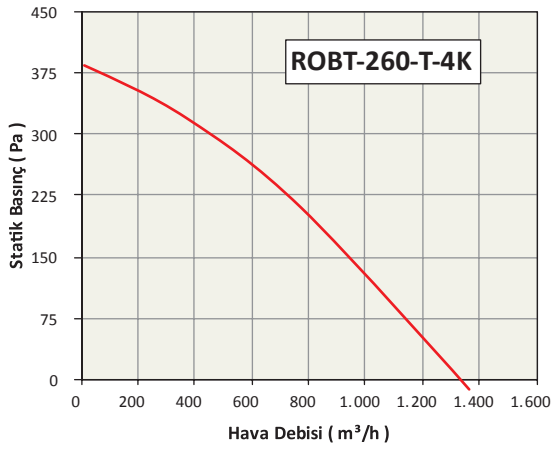
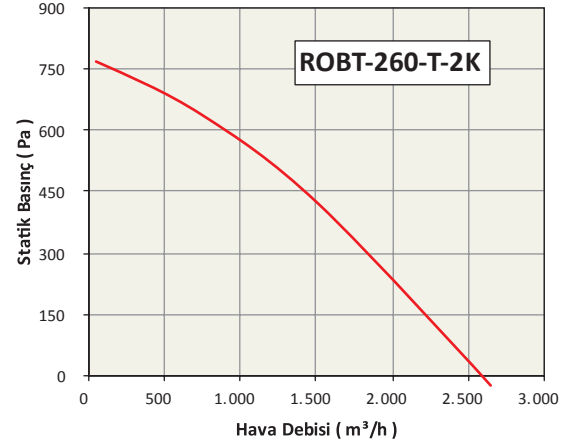
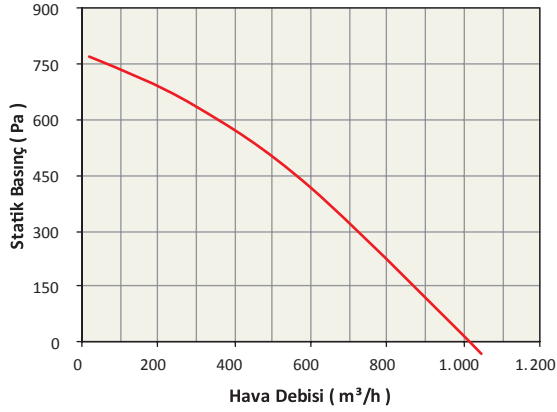



Discover the potential



NOT \_\_\_\_\_

\_\_\_\_\_

\_\_\_\_\_

\_\_\_\_\_

\_\_\_\_\_

\_\_\_\_\_

\_\_\_\_\_

\_\_\_\_\_

\_\_\_\_\_

\_\_\_\_\_

\_\_\_\_\_

\_\_\_\_\_

\_\_\_\_\_

\_\_\_\_\_

\_\_\_\_\_

\_\_\_\_\_

\_\_\_\_\_

\_\_\_\_\_

\_\_\_\_\_

\_\_\_\_\_

\_\_\_\_\_

\_\_\_\_\_

\_\_\_\_\_

\_\_\_\_\_

\_\_\_\_\_

\_\_\_\_\_

**ACTIVENT®**

Halkalı Merkez Mahallesi  
Şehit Yılmaz Özdemir Caddesi  
Sanayi Sokak No: 4  
Küçükçekmece, İstanbul, Türkiye

**P:** +90.212 698 02 25

**P:** +90.212 698 02 26

**P:** +90.212 565 73 03

[info@activent.com.tr](mailto:info@activent.com.tr)

[www.activent.com.tr](http://www.activent.com.tr)

